



Sanctuary

S H U T T E R S

Product Information & Specs
Aluminium Shutters

Application: Indoor, Outdoor and Wet Areas

PRODUCT PRICING



Aluminium

SURCHARGES	
ITEM	PRICE
Urban Louvre	
Café Shutter	
Tier on Tier	
Horizontal T Post	
Bay Window	
Corner Window	
Special Cut Out	
Lock	
Flush Bolt	

WARRANTIES	
Aluminium	3 Years

GENERAL INFORMATION

Cancellations and Modifications:

Orders placed with Sanctuary Shutters are processed in the timeliest manner possible. As such, any changes made to an order once placed cannot be guaranteed to be applied if the order is already in production. Initial costs, cancellations or any change costs will be the responsibility of the customer to cover.

All drawings, notes and emails with questions must be answered before an order is entered in to the production line. Delays in response to these will lead to longer lead times.

All factory/freight repairs are to have photographic/video proof. If neither are available at the time of placing the repair, it will be processed as a customer responsibility. Please ensure to send through photographic evidence when submitting these repairs to avoid being charge.

For special request/non-standard/limited availability items please check first with Head Office for availability. Any surcharges for these items will be the responsibility of the customer to cover, even if it is not listed on the price list.

All customers are responsible for having the most current price lists and product manuals. If unsure please contact the Sanctuary Shutters head office to confirm.

Warranty

Products that are made from timber/wood may show characteristics of their natural source such as grain patterns or blemishes. This gives each shutter its own unique quality and as such is not a defect or grounds for warranty.

Each finish used on our products is selected for its durability and quality. There are factors that may impact the application of these paints/stains on our natural products which are not covered under warranty, these include:

- Colour variations that may occur between different manufactured batches of a paint or stain finish.
- Naturally occurring variations in appearance created by artificial or natural lighting.
- Moisture, heat, light and exposure to weather.
- Environmental conditions such as pollutants, acid rain or other corrosive substances which may impact on finishes or cause corrosion.
- Damage, corrosion, wear, deteriorating or failure of standard components in sea coast applications or such other climates.
- Imperfections that cannot be seen at a distance of 1.2mtrs

This warranty applies only:

- To the original purchaser of the product (warranties are not transferable)
- When the product is professionally installed using the correct installation methods.
- For product in an owner-occupied residential home.

This warranty does not cover:

- Damage caused by improper maintenance, application of improper cleaning agents, methods or mishaps.
- Damage resulting from accidents such as, but not limited to: abuse, burning, flooding, cutting, pet damage, or smoke.
- Damaged cause by risks covered by a generally available home owner insurance policy.
- Damage cause by wetting or persistence of excessive moisture or exposure to very hot substances.

SHUTTER BREAKDOWN

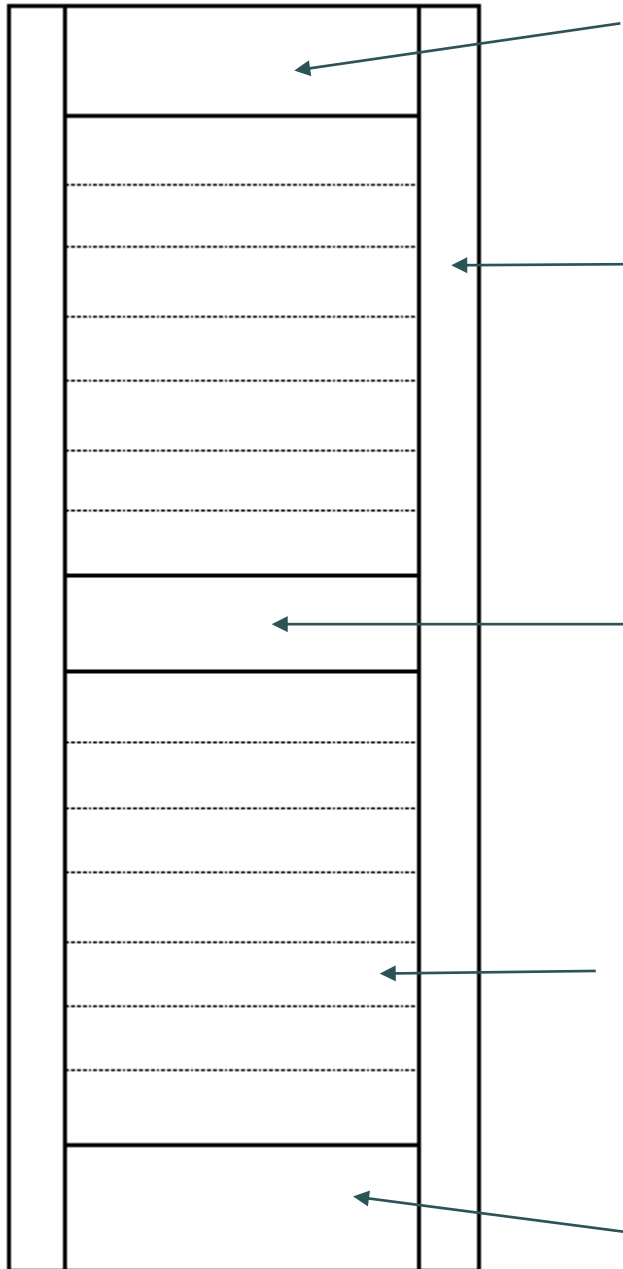

TOP RAIL

The horizontal bar at the top of the panel which gives it form, structure and stability

STILES

The stiles are the sides of every panel. See page #6 for the different stile options available

MID-RAILS

Mid-Rails provide structural support for the panel and are only required for panels over a certain height, or if a customer requests one. See page #6 for more information

LOUVRE BLADES

Louvres are the horizontal blades within the panel. See page #4 for different blade size options.

BOTTOM RAIL

The horizontal bar at the bottom of the panel which gives it form, structure and stability

LOUVRE OPTIONS

ELLIPTICAL BLADE

BLADE SIZE	89mm
Blade Thickness	11.5mm
Split Rotation Required	13 Louvres

Aluminium Blades

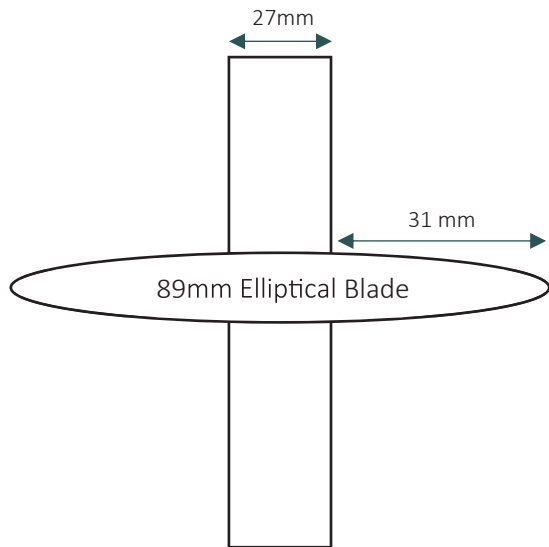

RAILS & T-POSTS

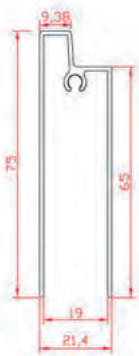

Adjusting rail

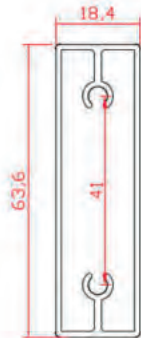

Rail



Mid Rail

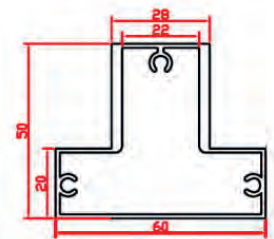

T50

COLOUR AND HINGE OPTIONS

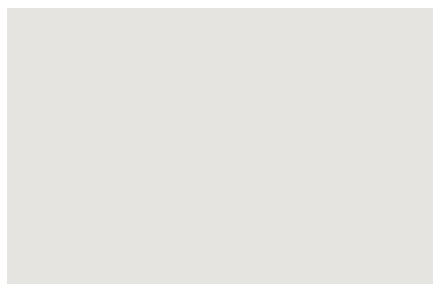

White

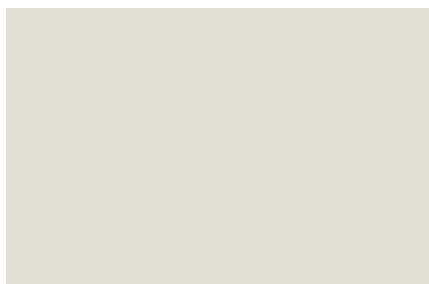

Cream



Grey



Dark Grey



Black

AVAILABLE COLOURS	Non Mortise Hinge
White	•
Black	•
Stainless Steel	•



NUMBER OF HINGES	
PANEL HEIGHT	HINGE QUANTITY
< 1300mm	2
1300 - 1800mm	3
1800mm - 2500mm	4
2500mm - 3000mm	5

LOCK & BOLT

Lock colour: silver and white available

Length: 17.1cm Width: 2.4cm

STILE OPTIONS

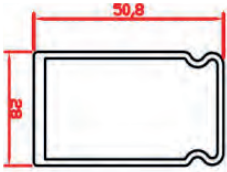

BS-Aluminium

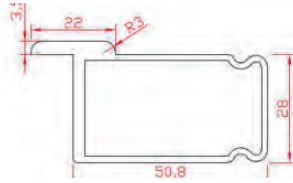

DBS-Aluminium

MID RAILS

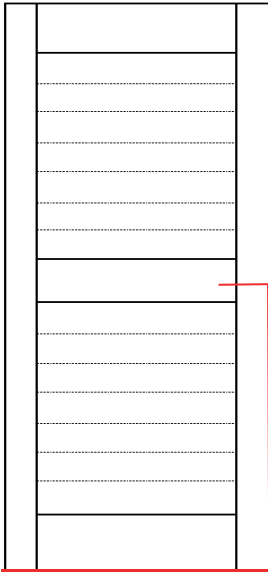

How to Measure:

Measure from the bottom of the opening to the centre point of the required mid rail.

Standard rail 76.2mm

Mid-rails required at 1500mm and 2400mm

Mid Rail placement is within + or – one blade size.

89mm Blade: +/- 38.1mm

If the mid-rail position is critical, ensure this is well noted on your order form. Please note, if there are multiple mid-rails on one panel only one midrail can be marked critical.

If you have shutters that require the same mid rail, or top and bottom rail height please ensure this is noted on the order.

TILT RODS



Clearview Tilt Rod

Tilt Rod offset 25.4mm from the edge if the blades

Tilt Rod Position: Rear of panel on the hinge side

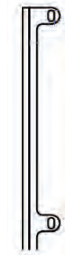

Important Notes

Where required the tilt rod will split equal in the middle, if not equal the bottom section will contain one more blade than the top.

Maximum blade control

89mm Blades – 13 pieces

INSTALLATION METHOD: HINGED IN L FRAME Face and Reveal Mount



Finish	Installation method	Panel width		Panel Height		Panel Breaks	
		min	max	min	max	Mid-Rail(s) required	Approx Split rotation by blade size
Aluminium	Hinged in L Frame	190	1000	254	3000	1500-2499	89
	Double Hinged	190	1300	254	3000	1500-2500	1035
Max Number of blades per tilt rod							13

MINIMUM REVEAL DEPTHS	
Hinged in L Frame	89mm Blade
	Clearview
	73

INSTALLATION METHOD: HINGED IN L FRAME

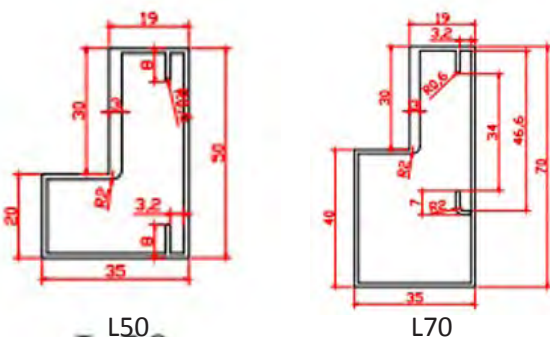

HOW TO MEASURE: HINGED IN L FRAME

Reveal Mount

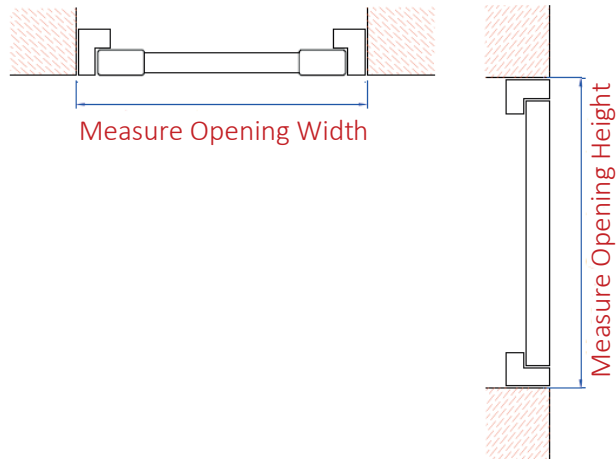

Face Mount

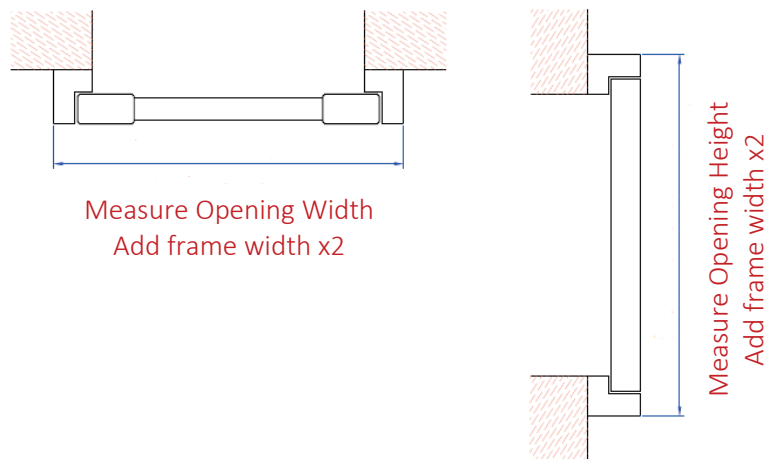

If you would like T-Posts, you have 2 options:

1. EVEN PANEL SPACING: The overall width will be equally split to determine the placement of your T posts.
2. UNEVEN PANEL SPACING: If you required uneven panel sizes, please note the sub widths on your order form, where possible please submit the order with a drawing.

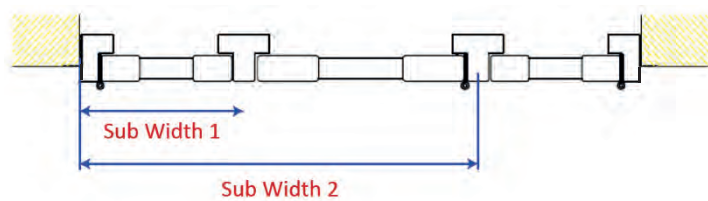

PANEL CONFIGURATION EXAMPLES: HINGED IN L FRAME

1 Panel, Configuration: L

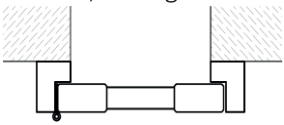

1 Panel, Configuration: R

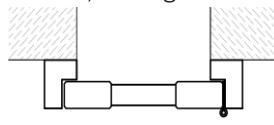

2 Panels, Configuration; L-DR

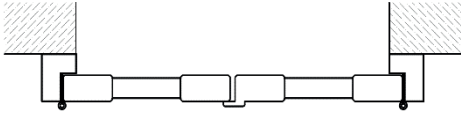

2 Panels with a T Post, Configuration; LTR

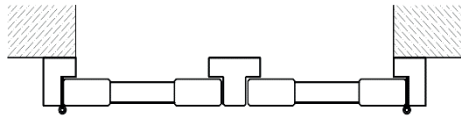

3 Panels, Configuration L-DRR

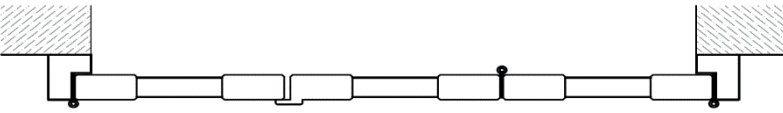

3 Panels with 2 T Posts, Configuration LTRTR

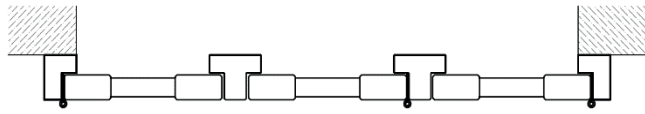

4 Panels, Configuration LL-DRR



4 Panels with a T Post, Configuration L-DRTL-DR

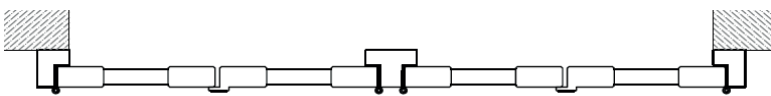

4 Panels with 3 T Posts, Configuration LRTLTR

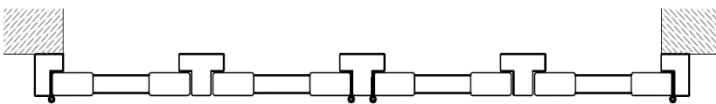

4 Panels with 3 Posts, Configuration LTL-DRTR

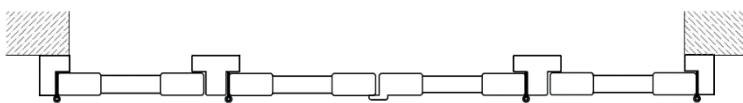

INSTALLATION METHOD: HINGED IN Z FRAME



Finish	Installation method	Panel width		Panel Height		Panel Breaks	
		min	max	min	max	Mid-Rail(s) required	Approx Split rotation by blade size
Aluminium	Hinged in Z Frame	190	1000	254	3000	1500-2499	89
	Double Hinged	190	1300	254	3000	1500-2500	1035
Max Number of blades per tilt rod							13

MINIMUM REVEAL DEPTHS	
Hinged in Z Frame	89mm Blade
	Clearview
	73

FRAME OPTIONS: HINGED IN Z FRAME

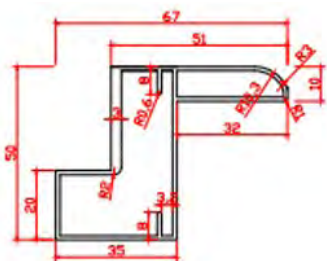

Z50

Z Frames are commonly used when there is no architrave, this frame will wrap around the reveal edge also making it ideal for covering out of square windows. The wide range of trims also allows you to achieve an architrave look.

A Z Frame is not recommended where an existing architrave is present, unless the opening is considerably out of square.

A Sill Plate Frame can be used along with Z Frames where it is unable to wrap around the opening, e.g. the bottom on a kitchen bench, the top on a bulkhead ceiling and so on. A sill plate is simply a L Frame in place of the Z Frame.

HOW TO MEASURE: HINGED IN Z FRAME

Reveal Mount Only

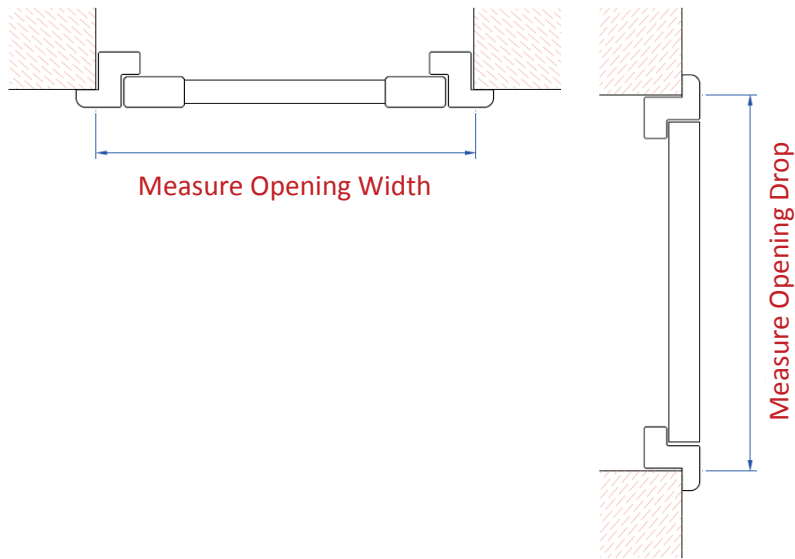

Important Notes:

The m2 price is calculated off the total finished shutter, the Z frame overlap will be added to the opening size when calculating the price.

If you would like T-Posts, you have 2 options:

1. EVEN PANEL SPACING: The overall width will be equally split to determine the placement of your T posts.
2. UNEVEN PANEL SPACING: If you required uneven panel sizes, please note the sub widths on your order form, where possible please submit the order with a drawing.

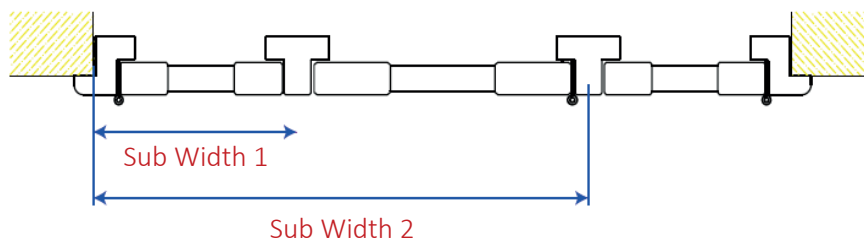

PANEL CONFIGURATION EXAMPLES: HINGED IN Z FRAME

1 Panel, Configuration: L

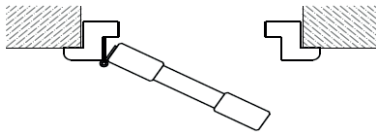

2 Panels, Configuration: L-DR

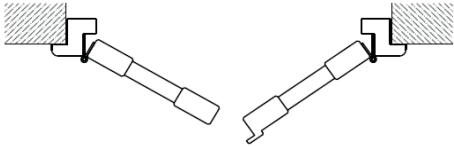

2 Panels with a T post, Configuration: LTR

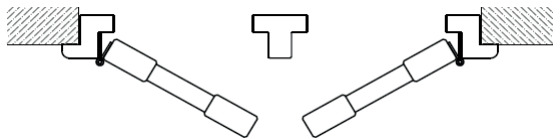

3 Panels, Configuration: L-DRR

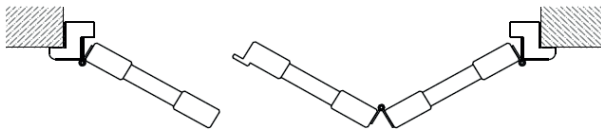

3 Panels with 2 T Posts, Configuration: LTRTR

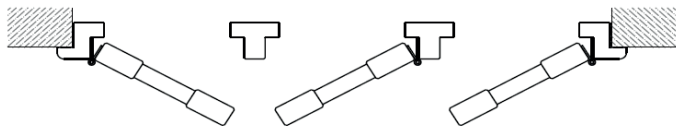

4 Panels, Configuration: LL-DRR

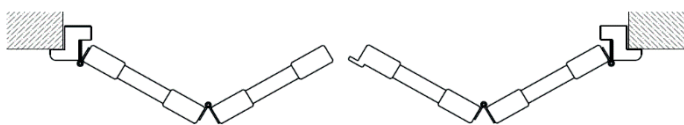

4 Panels with a T Post, Configuration: L-DRTL-D-R

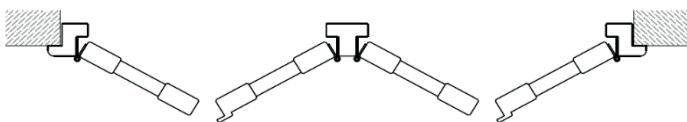

BAY & CORNER POSTS - Available for both hinged in L & Z Frames

For bay and corner windows when hinged in a L or Z frame to keep a consistent and clean look we suggest adding a bay or corner post (dependant on the angle)

To request a bay or corner post simply add it into your configuration.

Bay and corner shutter orders should be submitted with a drawing to ensure the factory have all the information to make the shutter off the correct post placement.

Custom bay posts are also available for different angles, please ensure to provide your angle requirement along with your drawings.

Paulownia and Basswood Posts

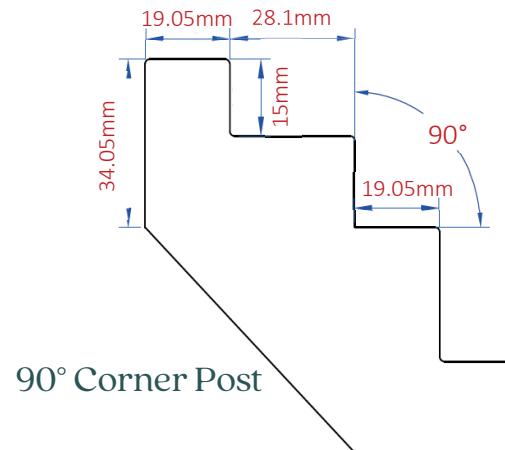
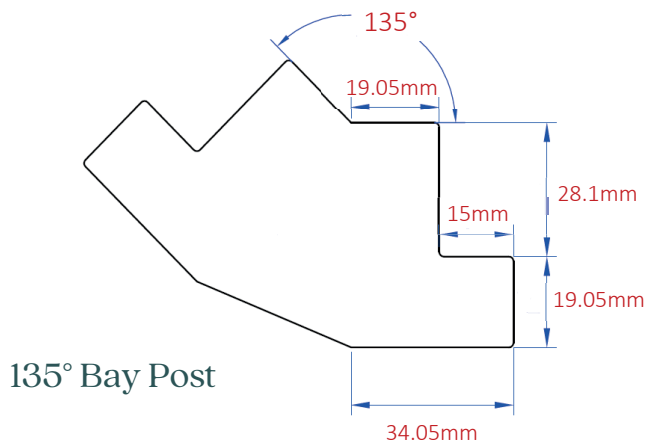

PVC Posts

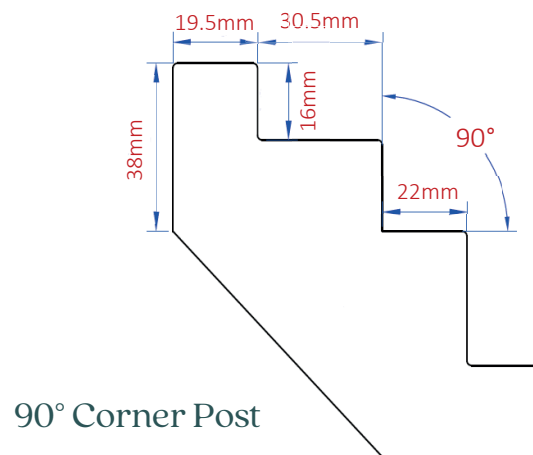
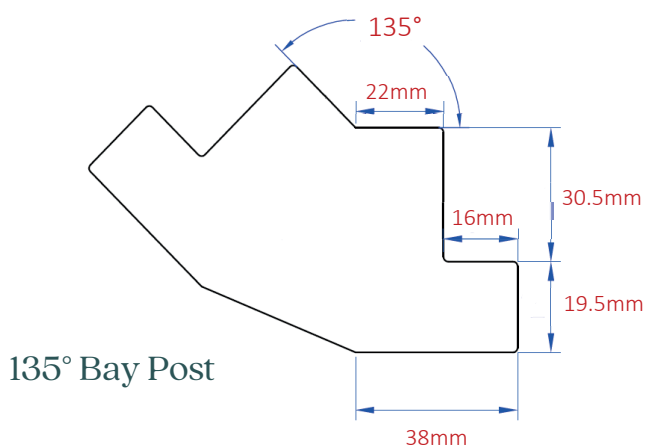

HOW TO MEASURE: CORNER & BAY WINDOWS

Bay Window: Inside Mount
Available with both L and Z Frames

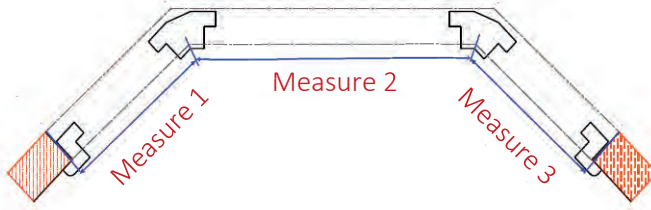

Bay Window: Outside Mount
Available with L Frames only

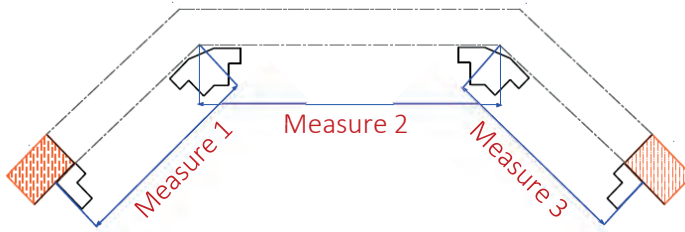

Corner Window: Inside Mount
Available with both L and Z Frames

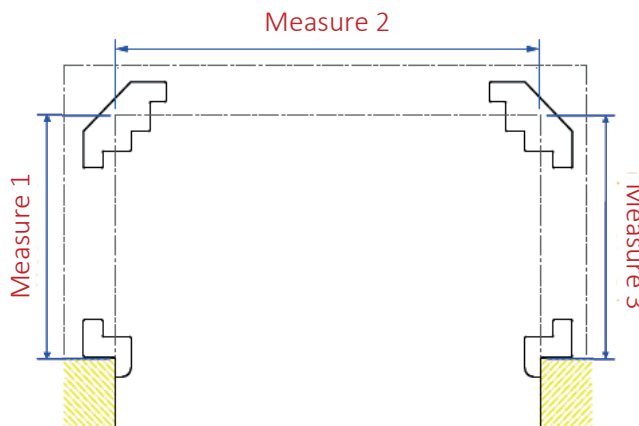

Corner Window: Outside Mount
Available with L Frames only

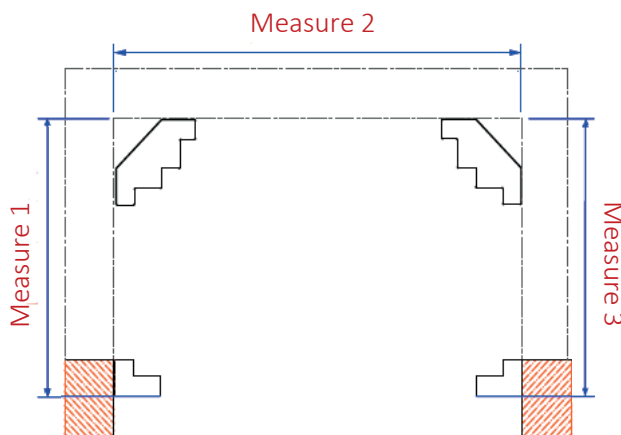

PANEL CONFIGURATION OPTIONS: CORNER & BAY WINDOWS

4 Panels and 2 bay posts, Configuration: LBL-DRBR

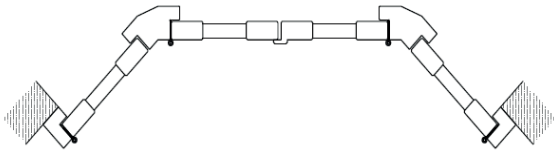

6 Panels and 2 bay posts, Configuration: LBLL-DRRBR

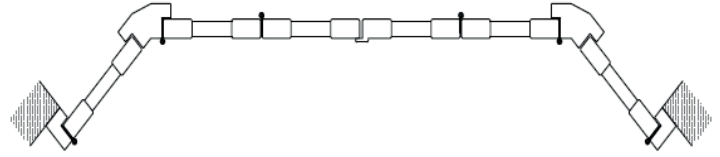

8 Panels and 2 bay posts, Configuration: L-DRBLL-DRRBL-DR

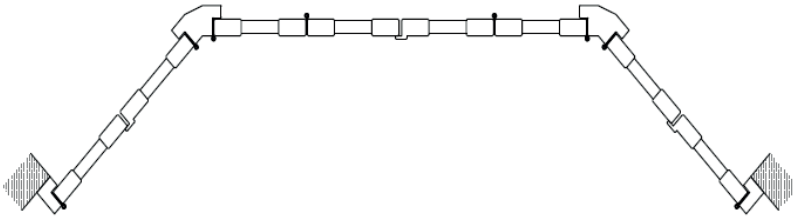

2 Panels and 1 corner post, Configuration: LCR

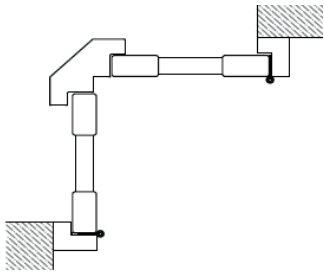

3 Panels and 1 corner post, Configuration: LCL-DR

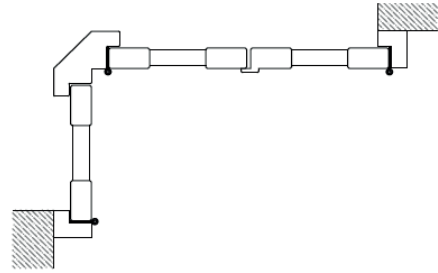

4 Panels, Configuration: L-DRCL-DR

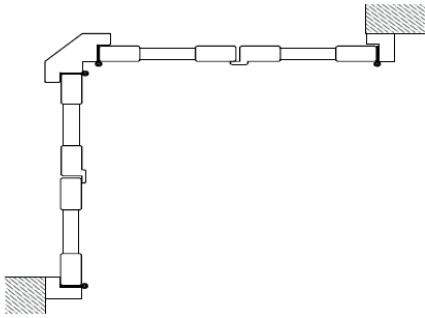

4 Panels, Configuration: LCL-DRCR

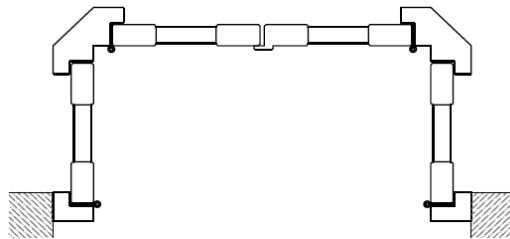

6 Panels, Configuration: LCLL-DRRCR

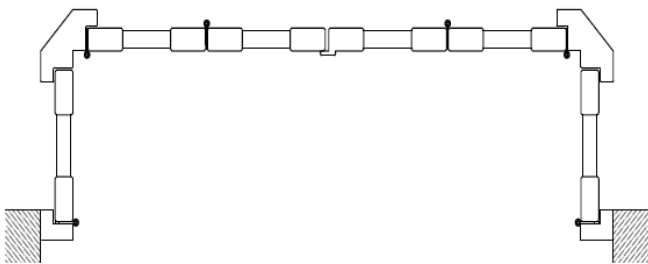

INSTALLATION METHOD: HINGED NO FRAME



Finish	Installation method	Panel width		Panel Height		Panel Breaks	
		min	max	min	max	Mid-Rail(s) required	Approx Split rotation by blade size
Aluminium	Hinged in L Frame	190	1000	254	3000	1500-2499	89
	Double Hinged	190	1300	254	3000	1500-2500	1035
Max Number of blades per tilt rod							13

MINIMUM REVEAL DEPTHS	
Hinged No Frame	89mm Blade
	Clearview
	73

HOW TO MEASURE: HINGED NO FRAME

Option 1: Non-Mortise Hinged – Reveal Mount Only

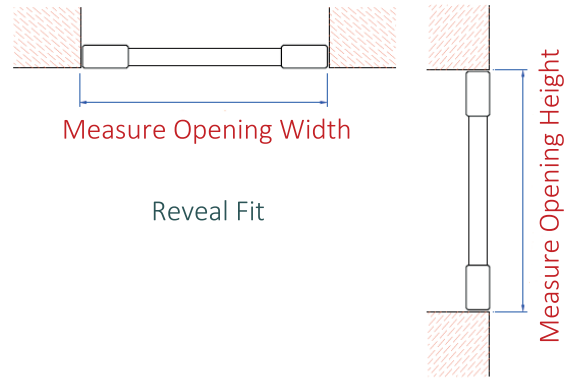

Option 2: Pivot Hinge – Reveal and Face Fit

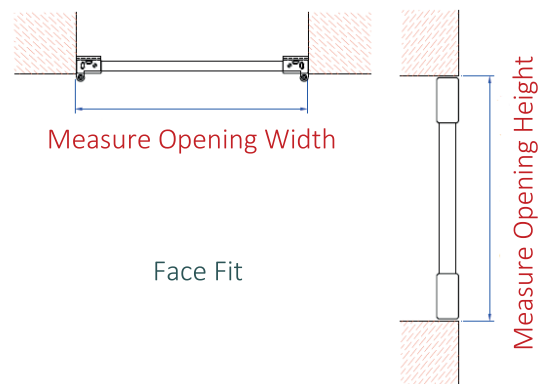
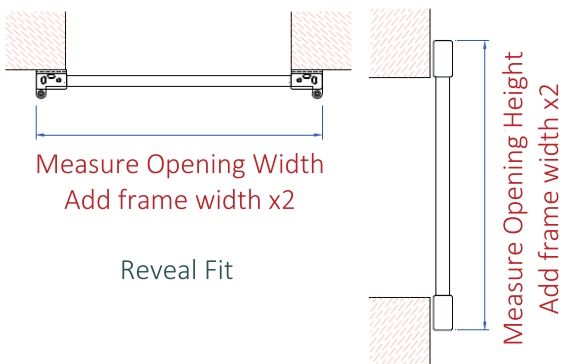

Option 2: L Hinge and Hang Strip – Reveal Mount Only

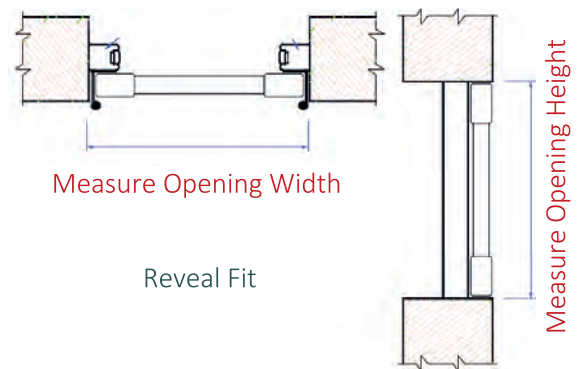
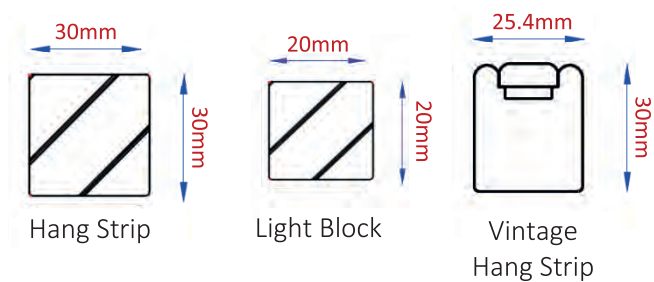

PANEL CONFIGURATION EXAMPLES: HINGED NO FRAME

1 Panel, Configuration: L

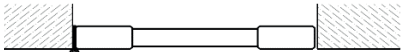

1 Panel, Configuration: R

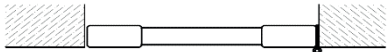

2 Panels, Configuration: L-DR



3 Panels, Configuration: LL-DR

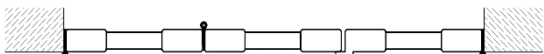

4 Panels, Configuration: LL-DRR



INSTALLATION METHOD: FIXED



Finish	Installation method	Panel width		Panel Height		Panel Breaks	
		min	max	min	max	Mid-Rail(s) required	Approx Split rotation by blade size
Aluminium	Fixed	190	1000	254	3000	1500-2499	89
Max Number of blades per tilt rod							13

MINIMUM REVEAL DEPTHS	
Fixed	89mm Blade
	Clearview
	73

INSTALLATION OPTIONS: FIXED

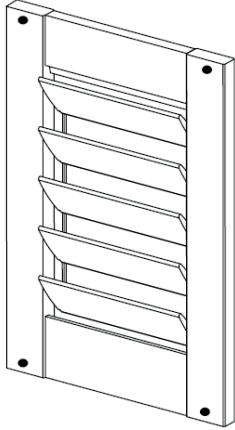

Fixed with Aluminium Round Magnets

Panel can be removed

- Option 1: Fixed with Aluminium Round Magnets in L Frame
- Option 2: Fixed with Aluminium Round Magnets in Z Frame
- Option 3: Fixed with Aluminium Round Magnets with Light Block
- Option 4: Panel only with Aluminium Round Magnets

HOW TO MEASURE: FIXED

Fixed in U Channel

Measure Opening Width

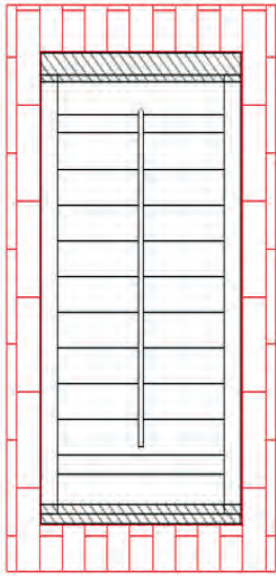
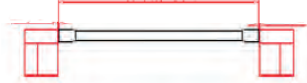

Fixed in In L or Z Frame

Measure Opening Width

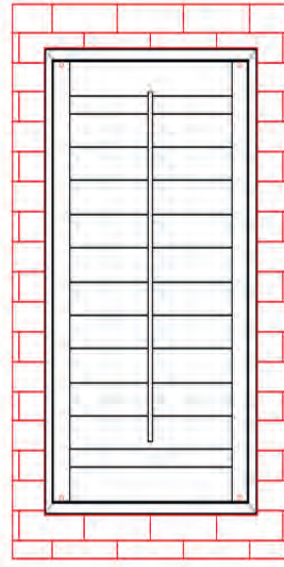

PANEL CONFIGURATION EXAMPLES: FIXED

1 Panel, Configuration: F

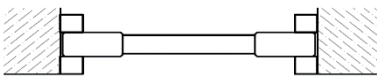

2 Panel, Configuration: FF

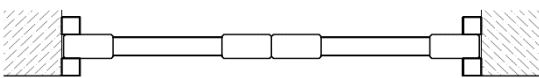

3 Panel, Configuration: FFF

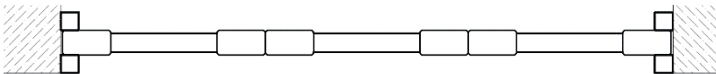

4 Panel, Configuration: FFFF



INSTALLATION METHOD: MULTI-FOLD



Finish	Installation method	Panel width		Panel Height		Panel Breaks		
		min	max	min	max	Mid-Rail(s) required	Approx Split rotation by blade size	
Aluminium	Multifold	190	650	254	3000	1500-2499	89	
Max Number of blades per tilt rod								13

MINIMUM REVEAL DEPTHS	
Multifold	89mm Blade
	Clearview
	73

OPTIONS: MULTI-FOLD

Track Options

- A. If you need top, bottom, left and right sideboards, we will supply the standard top tracks and C Shape Bottom track for you.
- B. If you do not need the bottom board, we will supply you the standard top tracks and M shape bottom track for you directly
- C. If you only need us to supply the top and bottom track for you and dig the slot, we will supply you the standard top tracks and U shape bottom track directly.

Fascia

65mm x 12mm Thickness

Valance

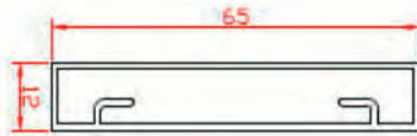

Side Boards

75mm x 20mm Thickness

Top & Bottom Board

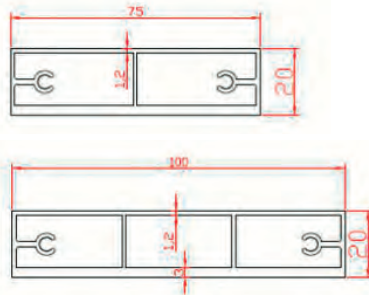

Left & Right Board

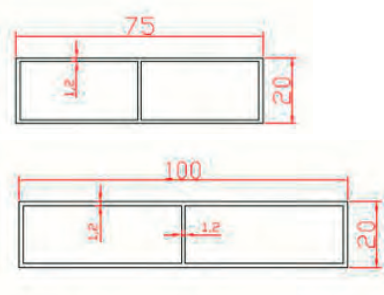

Installation Type

Standard Fold: The panels open into the room (Open towards you)

Reverse Fold: The panels open to the outside (Away from you)

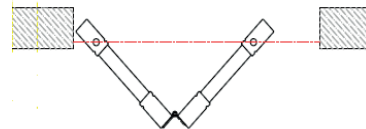

HOW TO MEASURE: MULTIFOLD

Reveal Mount

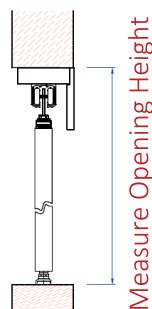
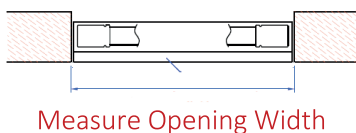

Face Mount

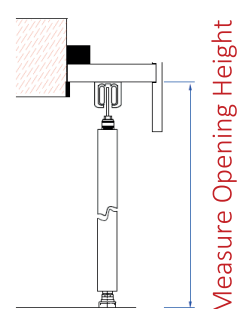
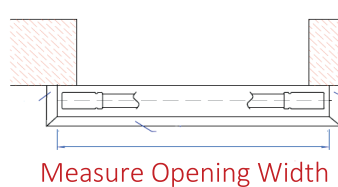

PANEL CONFIGURATION OPTIONS: MULTI-FOLD

2 Panels, Configuration: LL

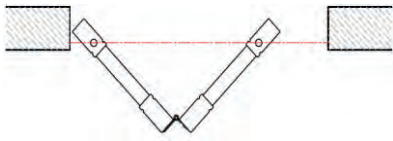

2 Panels, Configuration: RR

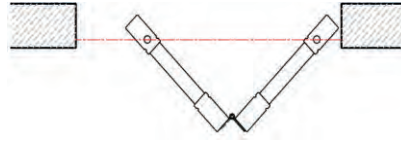

4 Panels, Configuration: LLLL

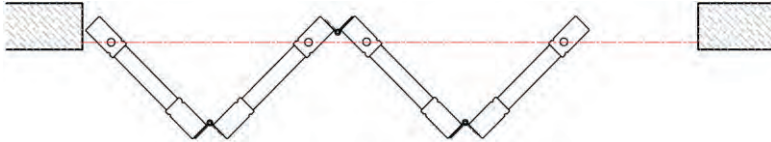

4 Panels, Configuration: RRRR

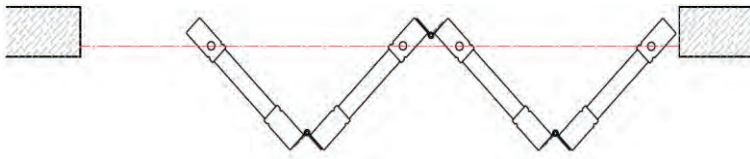

4 Panels, Configuration: LLRR

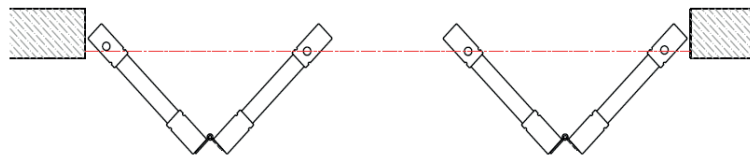

6 Panels, Configuration: LLLRR

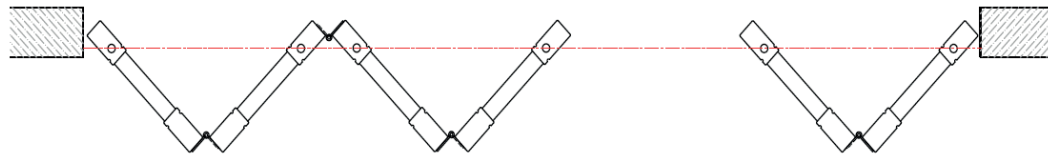

6 Panels, Configuration: LLRRRR

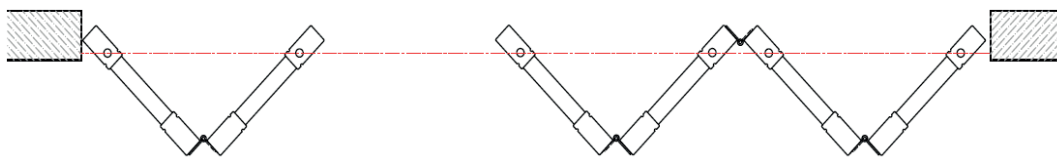

Important Notes:

When ordering multi-fold shutters using a centre tilt rod with more than two panels folded to one side, the tilt rod will automatically be staggered by 7mm to avoid any collision.

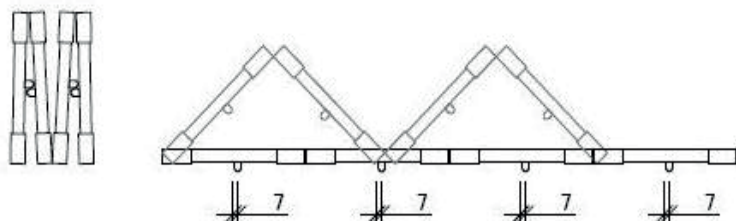

INSTALLATION METHOD: SLIDING



Finish	Installation method	Panel width		Panel Height		Panel Breaks	
		min	max	min	max	Mid-Rail(s) required	Approx Split rotation by blade size
Aluminium	Sliding	190	1200	254	3000	1500-2499	89
Max Number of blades per tilt rod							13

MINIMUM REVEAL DEPTHS	
	89mm Blade
Sliding	Clearview
Tracks Closed	122
Tracks Open	182

HOW TO MEASURE: SLIDING

Reveal Mount

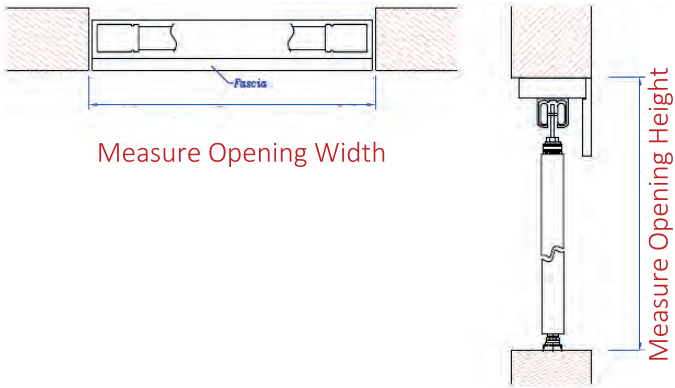

Face Mount

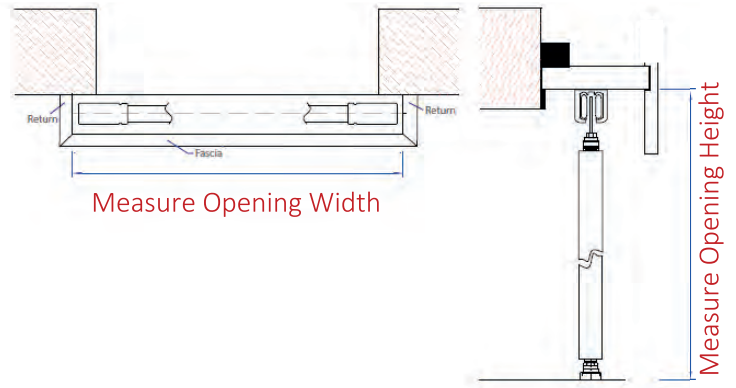

PANEL CONFIGURATION EXAMPLES: SLIDING

2 Track System, 2 Panels Configuration: BF

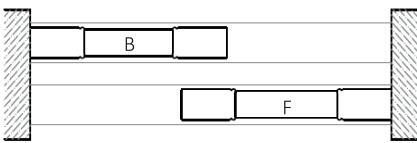

2 Track System, 3 Panels Configuration: BFB

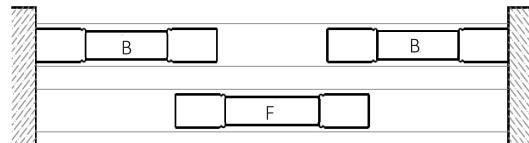

2 Track System, 3 Panels Configuration: FBB

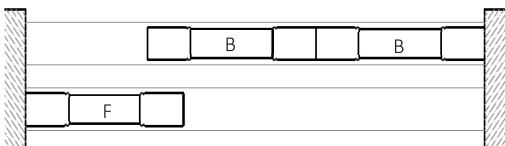

3 Track System, 3 Panels Configuration: FMB

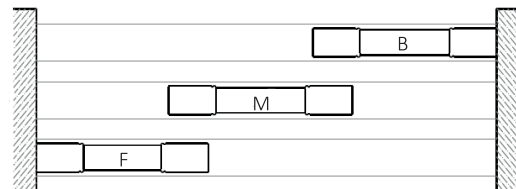

2 Track System, 4 Panels Configuration: BFFB

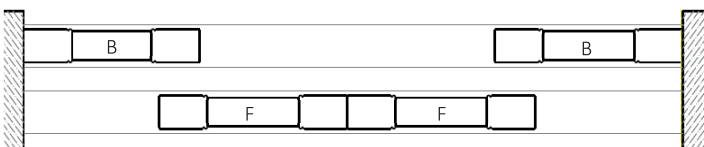

OPTIONS: SLIDING

Track Options

- A. Track C with Bottom Board
- B. M Track
- C. T Shape Bottom Guide

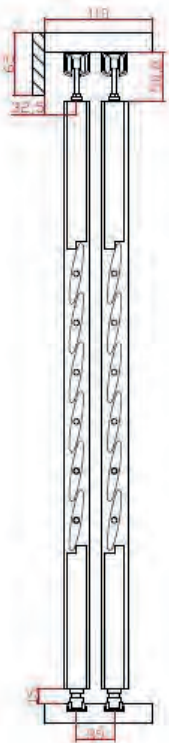

Track C with Bottom Board

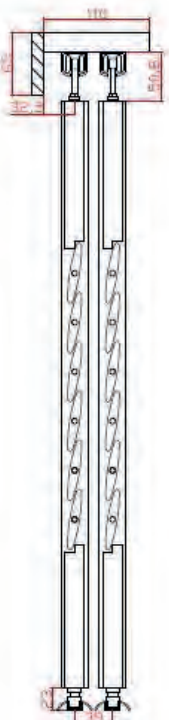

M Track

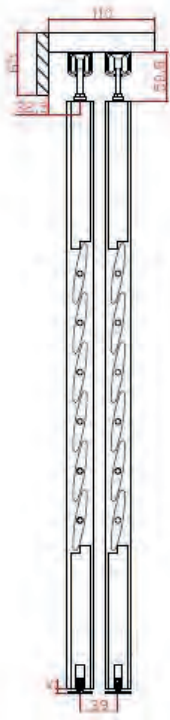

T Shape Bottom Guide

Fascia

100mm x 12mm Thickness

150mm x 12mm Thickness

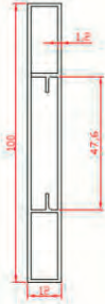

Side Boards

100 x 20mm Thickness

140 x 20mm Thickness

160 x 20mm Thickness

200 x 20mm Thickness

220 x 20mm Thickness

Top & Bottom Board

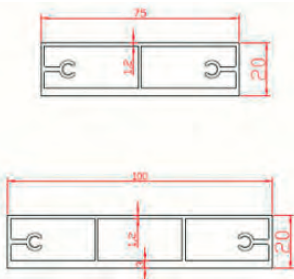

Left & Right Board

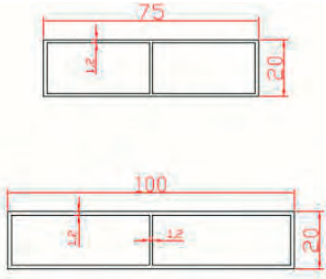

OPTIONS: SLIDING

Blade: 89mm
Blades Closed

Blade: 89mm
Blades Open

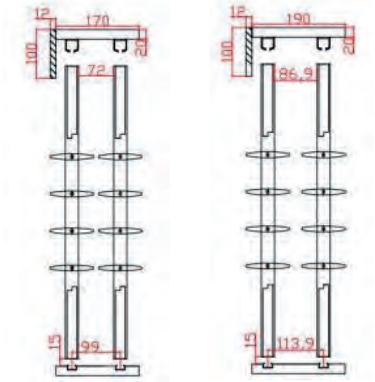
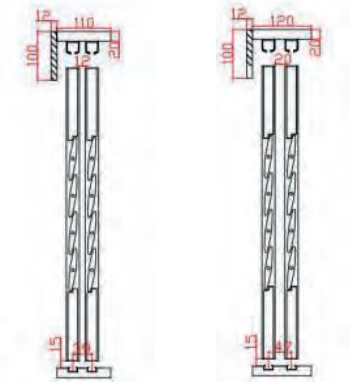

Clearview or
Concealed

Centre or
Offset

Clearview or
Concealed

Centre or
Offset

SOLID PANELS

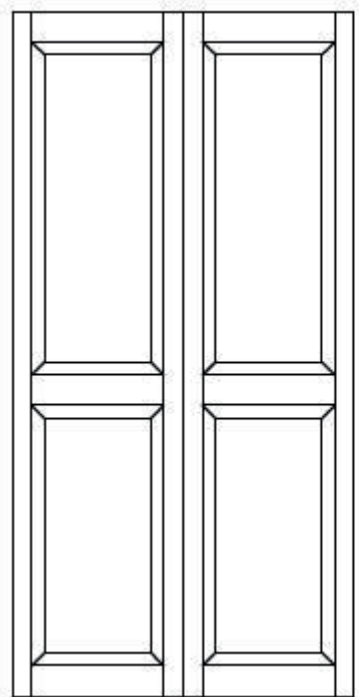

Solid Panels Only

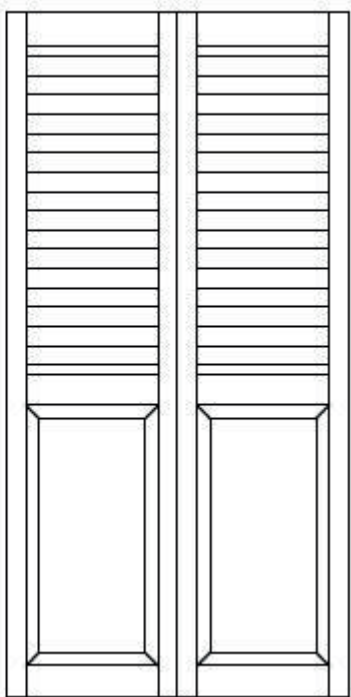

Combination

Solid Panel Options Available:

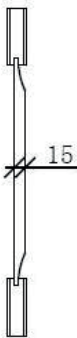

Option 1: Single raise

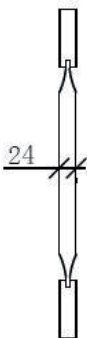

Option 2: Double raise

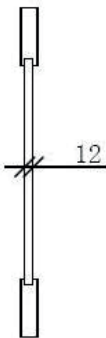

Option 3: Flat

FRENCH DOOR CUT-OUTS

Square and Round cut outs available.

Orders with French door cut outs must be accompanied by the correct French Door Cut out order form.

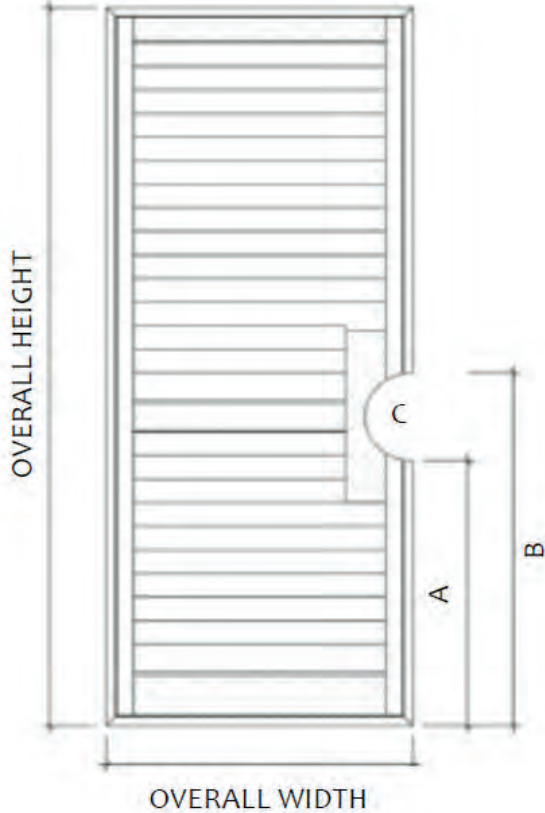
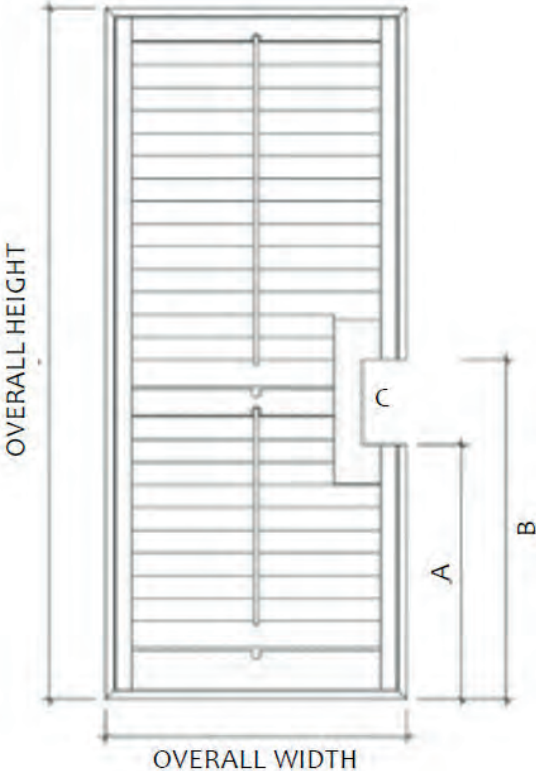

Cut-out Options Available

Type A: Curved Flush Cut-out

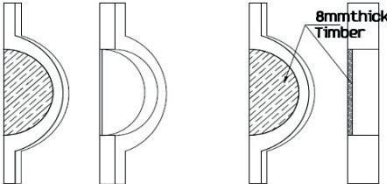

Type B: Curved Offset Cut-out

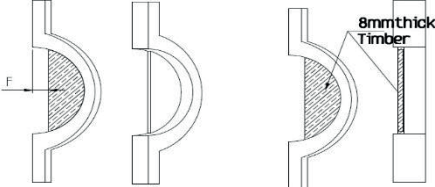

Type C: Rectangular Flush Cut-out

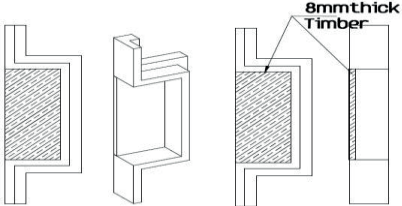

Type D: Rectangular Offset Cut-out

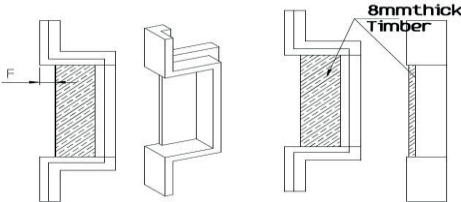



Sanctuary

S H U T T E R S

www.sanctuaryshutters.co.uk



HARRIS
PARTS
WINDOW BLIND SOLUTIONS

Unit 400, Catesby Business Park, Kings Norton, Birmingham, West Midlands, B38 8SE

Tel: 0121 433 3302 | Fax: 0121 459 5438

Email: sales@harrisparts.co.uk | Web: www.harrisparts.co.uk



@harrisparts1



/harrispartslimited