



Sanctuary

S H U T T E R S

Product Information & Specs
Paulownia | Basswood | PVC



PRODUCT PRICING



PVC



Paulownia Painted



Basswood Painted



Paulownia Stained

SURCHARGES

ITEM	PRICE
Urban Louver	
Concealed Tilt Rod	
Cafe Shutter	
Tier on Tier	
Horizontal T Post	
Bay Window	
Corner Window	
Special Cut Out	
Offset Tilt Rod	
Solid Panel	

WARRANTIES

PVC	3 Years
Paulownia Painted	2 Years
Basswood Painted	2 Years
Paulownia Stained	2 Years

GENERAL INFORMATION

Cancellations and Modifications:

Orders placed with Sanctuary Shutters are processed in the timeliest manner possible. As such, any changes made to an order once placed cannot be guaranteed to be applied if the order is already in production. Initial costs, cancellations or any change costs will be the responsibility of the customer to cover.

All drawings, notes and emails with questions must be answered before an order is entered in to the production line. Delays in response to these will lead to longer lead times.

All factory/freight repairs are to have photographic/video proof. If neither are available at the time of placing the repair, it will be processed as a customer responsibility. Please ensure to send through photographic evidence when submitting these repairs to avoid being charge.

For special request/non-standard/limited availability items please check first with Head Office for availability. Any surcharges for these items will be the responsibility of the customer to cover, even if it is not listed on the price list.

All customers are responsible for having the most current price lists and product manuals. If unsure please contact the Sanctuary Shutters head office to confirm.

Warranty

Products that are made from timber/wood may show characteristics of their natural source such as grain patterns or blemishes. This gives each shutter its own unique quality and as such is not a defect or grounds for warranty.

Each finish used on our products is selected for its durability and quality. There are factors that may impact the application of these paints/stains on our natural products which are not covered under warranty, these include:

- Colour variations that may occur between different manufactured batches of a paint or stain finish.
- Naturally occurring variations in appearance created by artificial or natural lighting.
- Moisture, heat, light and exposure to weather.
- Environmental conditions such as pollutants, acid rain or other corrosive substances which may impact on finishes or cause corrosion.
- Damage, corrosion, wear, deteriorating or failure of standard components in sea coast applications or such other climates.
- Imperfections that cannot be seen at a distance of 1.2mtrs

This warranty applies only:

- To the original purchaser of the product (warranties are not transferable)
- When the product is professionally installed using the correct installation methods.
- For product in an owner-occupied residential home.

This warranty does not cover:

- Damage caused by improper maintenance, application of improper cleaning agents, methods or mishaps.
- Damage resulting from accidents such as, but not limited to: abuse, burning, flooding, cutting, pet damage, or smoke.
- Damaged cause by risks covered by a generally available home owner insurance policy.
- Damage cause by wetting or persistence of excessive moisture or exposure to very hot substances.

SHUTTER BREAKDOWN

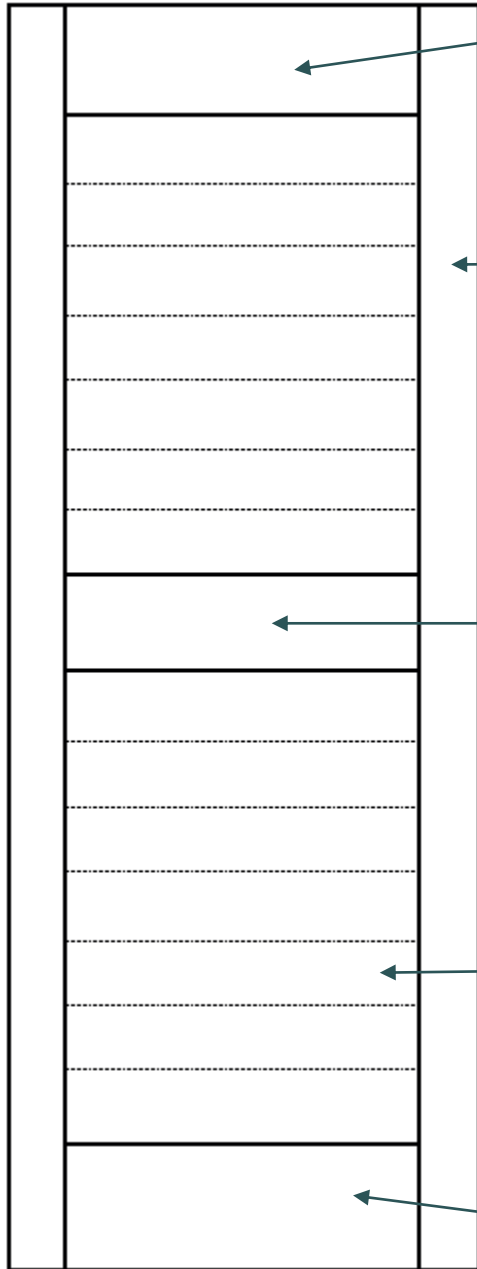

TOP RAIL

The horizontal bar at the top of the panel which gives it form, structure and stability

STILES

The stiles are the sides of every panel. See page #6 for the different stile options available

MID-RAILS

Mid-Rails provide structural support for the panel and are only required for panels over a certain height, or if a customer requests one. See page #6 for more information

LOUVRES

Louvres are the horizontal pieces within the panel. See page #4 for different louvre size options.

BOTTOM RAIL

The horizontal bar at the bottom of the panel which gives it form, structure and stability

LOUVRE OPTIONS

Elliptical Louvre			
Louvre Sizes	64mm	89mm	114mm
Louvre Thickness	10.5mm	11.5mm	12.2mm
Split Rotation Required	15 louvres	13 louvres	11 louvres

Timber Louvres

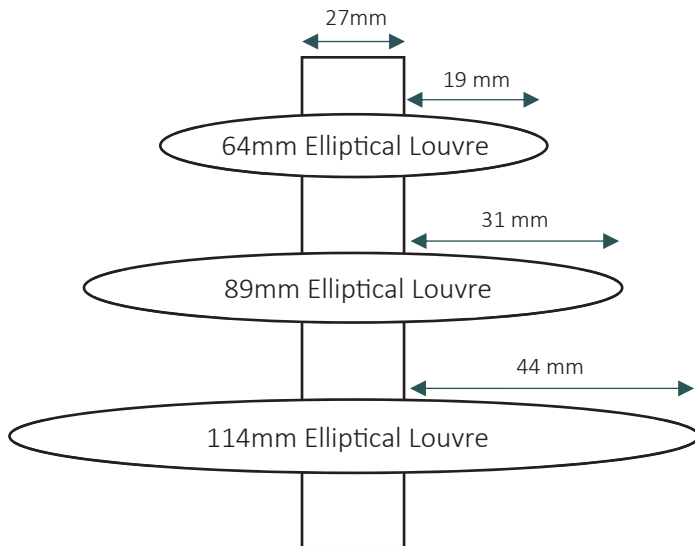

Our Tip

Take into consideration the height of the shutter when picking your louvre size. The smaller the height the less louvres. I.e.: for panels very small in height consider using the smallest louvre options. Where with taller panels consider the bigger louvre sizes to avoid the shutter looking too cluttered.

Also take into consideration the minimum reveal depths for each louvre size.

PVC Blades

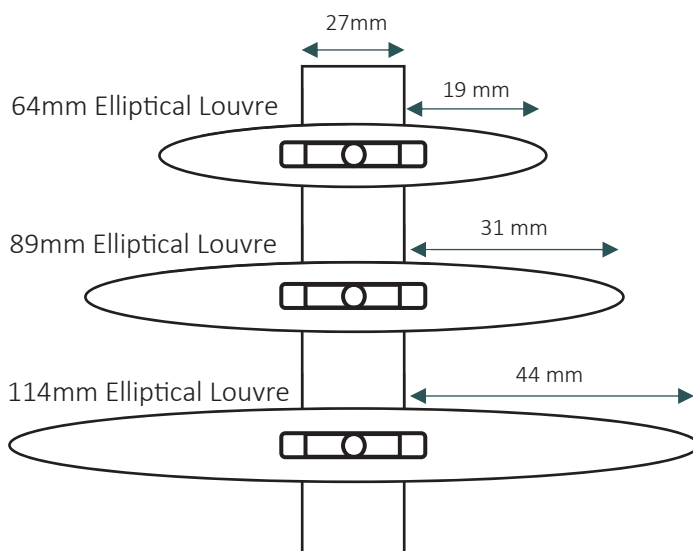

Important Notes:

Each PVC louvre comes as standard with an aluminium insert for reinforcement.

COLOUR AND HINGE OPTIONS

Panel Colour	Finish Type	Available In
PY01 Vivid White	Painted	Paulownia, Basswood and PVC
PY02 Snow	Painted	Paulownia, Basswood and PVC
PY03 Cotton White	Painted	Paulownia, Basswood and PVC
PY04 Pure White	Painted	Paulownia, Basswood and PVC
PY05 Cream White	Painted	Paulownia, Basswood and PVC
PY06 Egg Shell	Painted	Paulownia, Basswood and PVC
PY07 Oyster	Painted	Paulownia, Basswood and PVC
PY08 Pearl	Painted	Paulownia, Basswood and PVC
PY09 Modern White	Painted	Paulownia, Basswood and PVC
PY10 White Swan	Painted	Paulownia, Basswood and PVC
PY11 Danish Cream	Painted	Paulownia, Basswood and PVC
PY12 Handmade Linen	Painted	Paulownia, Basswood and PVC
PY13 Amazon Vine	Painted	Paulownia, Basswood and PVC
PY14 Aamp Art	Painted	Paulownia, Basswood and PVC
PY15 Unforgettable	Painted	Paulownia, Basswood and PVC
PY16 White Dune	Painted	Paulownia, Basswood and PVC
BY01 Bark	Brush	Paulownia Only
BY02 Branch	Brush	Paulownia Only
BY03 Fern	Brush	Paulownia Only
BY04 White Wash	Brush	Paulownia Only
SY01 Burlly	Stain	Paulownia Only
SY02 Black	Stain	Paulownia Only
SY03 Grain	Stain	Paulownia Only
SY04 Walnut	Stain	Paulownia Only
SY05 Torida	Stain	Paulownia Only
SY06 New Fruit Wood	Stain	Paulownia Only
SY07 Sage	Stain	Paulownia Only
SY08 Sand Dollar	Stain	Paulownia Only
SY09 Pear	Stain	Paulownia Only
SY10 Wine	Stain	Paulownia Only

Available Colours	Non Mortise Hinge	L Shape Hinge	Bi-Fold Hinge	Pivot Hinge	Hidden Hinge
White	✓	✓	✓	✓	✗
Black	✓	✓	✓	✓	✗
Rub Bronze	✓	✓	✓	✗	✗
Brass	✓	✓	✓	✓	✗
Antique Brass	✓	✓	✓	✓	✗
Stainless Steel	✓	✓	✓	✓	✓
Chrome	✓	✓	✓	✗	✗

Number of Hinges	
Panel Height	Hinge Quantity
< 1300mm	2
1300 – 1800mm	3
1800mm – 2500mm	4
2500mm – 3000mm	5

Important Notes:

Any custom colour requests must be supplied with the colour reference code from the Dulux Fandex World of Colour Series 2

STILE OPTIONS

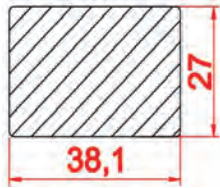

38mm Butt

Paulownia and Basswood

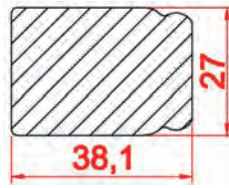

38mm Beaded

Paulownia and Basswood

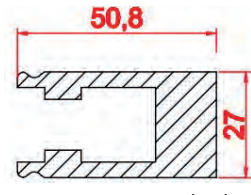

51mm Beaded
PVC

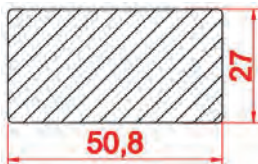

51mm Butt

Paulownia and Basswood

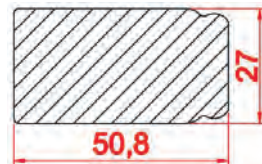

51mm Beaded

Paulownia and Basswood

MID-RAILS

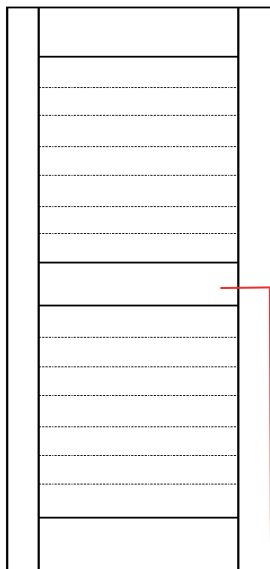

How to Measure:

Measure from the bottom of the opening to the centre point of the required mid rail.

Standard rail 76.2mm

Mid-rails required at 1500mm and 2400mm

Mid Rail placement is within + or – one louver size.

64mm Louvre: +/- 25.4mm

89mm Louvre: +/- 38.1mm

114mm Louvre: +/- 50.8mm

If the mid-rail position is critical, ensure this is well noted on your order form. Please note, if there are multiple mid-rails on one panel only one mid-rail can be marked critical.

If you have shutters that require the same mid rail, or top and bottom rail height please ensure this is noted on the order.

TILT RODS

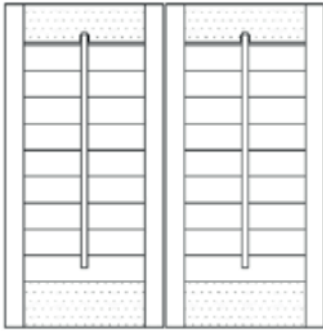

Centre Tilt Rod

Tilt rod in the centre of the blades

Tilt Rod Position: Front of panel

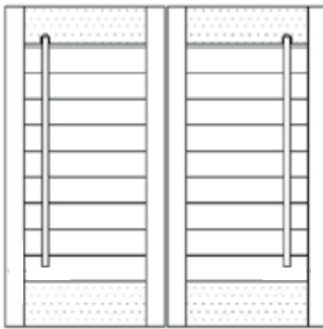

Offset Tilt Rod

Tilt Rod offset 25.4mm from the edge of the blades

Tilt Rod Position: Front of panel on the hinge side

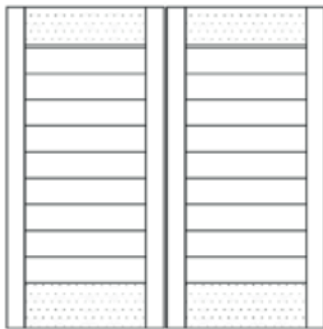

Clearview Tilt Rod

Tilt Rod offset 25.4mm from the edge of the blades

Tilt Rod Position: Rear of panel on the hinge side



Clearview for
Paulownia, Basswood
and PVC

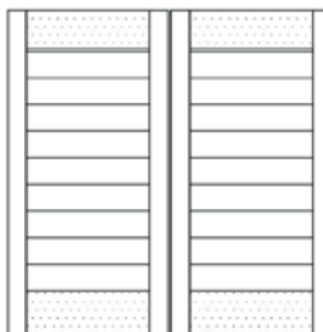

Concealed Tilt Rod

Best option for a fully uninterrupted view

Tilt Rod Position: Inside stiles, unable to be seen

Important Notes:

Where required the tilt rod will split equal in the middle, if not equal the bottom section will contain one more blade than the top.

Maximum blade control

64mm Louvres – 15 pieces

89mm Louvres – 13 pieces

114mm Louvres – 11 pieces

INSTALLATION METHOD: HINGED IN L FRAME — Face and Reveal Mount



Finish	Installation Method	Panel WIDTH		Panel HEIGHT		Panel Breaks			
		Min	Max	Min	Max	Mid-Rail(s) Required	Approximate split rotation by louvre size		
							64	89	114
Paulownia	Hinged in L Frame	190	850	254	3000	1500, 2500	830	1035	1135
	Double Hinged	190	425	254	3000	1500, 2500	830	1035	1135
Basswood	Hinged in L Frame	190	850	254	3000	1500, 2500	830	1035	1135
	Double Hinged	190	325	254	3000	1500, 2500	830	1035	1135
PVC	Hinged in L Frame	190	850	254	3000	1500, 2500	830	1035	1135
	Double Hinged	190	425	254	3000	1500, 2500	830	1035	1135
Note: The factory will automatically split the tilt if order sizes exceed factory standards				Maximum number of louvres per tilt rod			15	13	11

** Please note double hinged overall width cannot exceed 850mm for Paulownia and PVC, 650mm for Basswood

Minimum Reveal Depths									
Hinged in L Frame	64mm Louvre			89mm Louvre			114mm Louvre		
	Centre	Clearview	Concealed	Centre	Clearview	Concealed	Centre	Clearview	Concealed
	50.5	60.5	50.5	63	73	63	75.5	85.5	75.5

FRAME OPTIONS – HINGED IN L FRAME

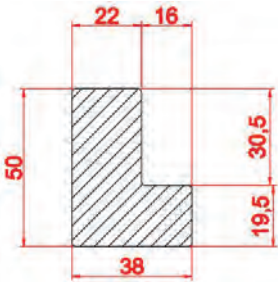

Butt L50
Paulownia and Basswood

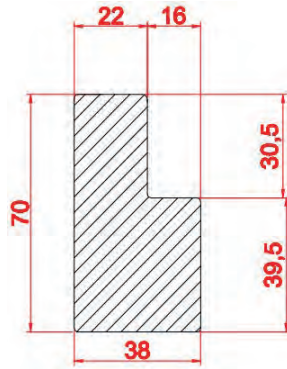

Butt L70
Paulownia and Basswood

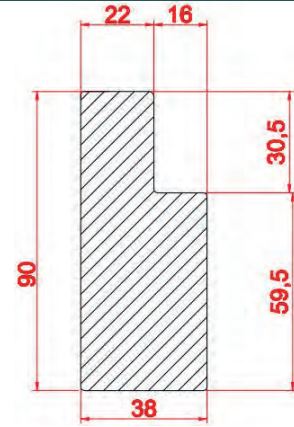

Butt L90
Paulownia and Basswood

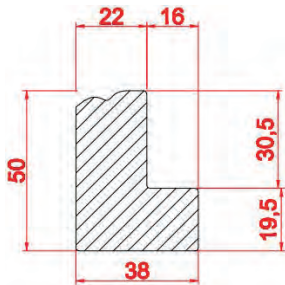

Beaded S-CS 50mm
Paulownia and Basswood

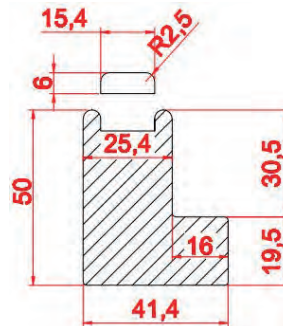

Vintage F50 50mm
Paulownia and Basswood

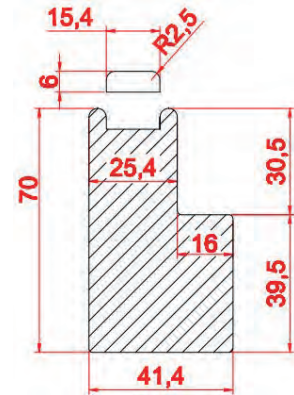

Vintage F70 70mm
Paulownia and Basswood

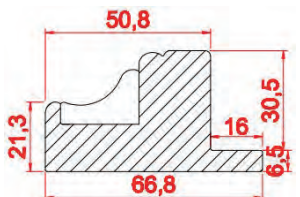

Classic Deco 50mm D1
Paulownia and Basswood

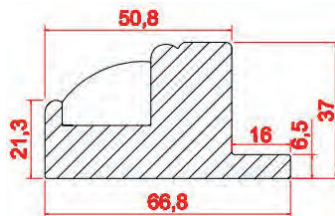

Camber Deco 50mm D2
Paulownia and Basswood

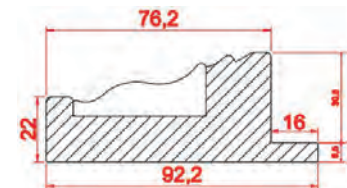

Ridge Deco 76mm D3
Paulownia and Basswood

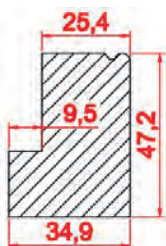

Beaded L50
PVC

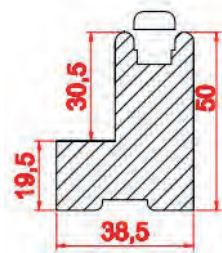

Vintage F50 50mm
PVC

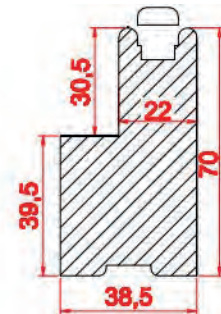

Vintage F70 50mm
PVC

HOW TO MEASURE – HINGED IN L FRAME

Reveal Mount

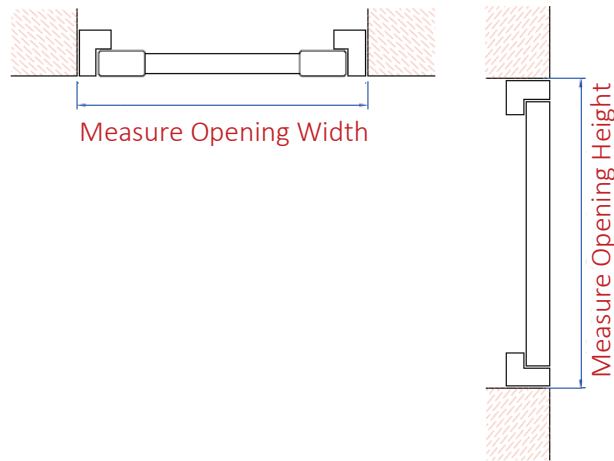

Face Mount

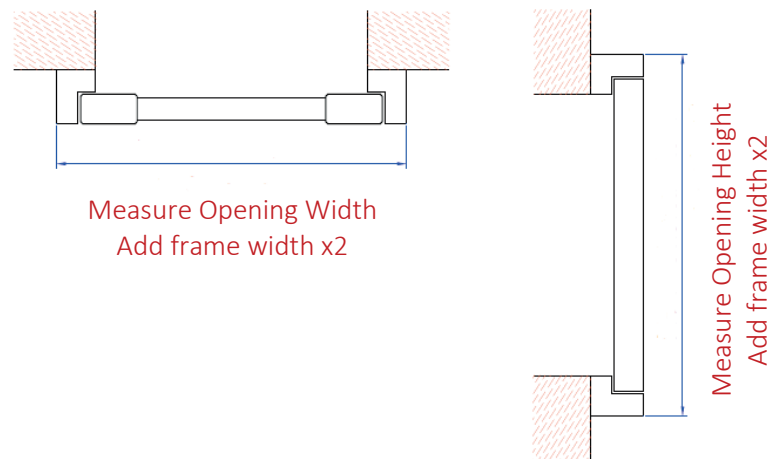

If you would like T-Posts, you have 2 options:

1. EVEN PANEL SPACING: The overall width will be equally split to determine the placement of your T posts.
2. UNEVEN PANEL SPACING: If you required uneven panel sizes, please note the sub widths on your order form, where possible please submit the order with a drawing.

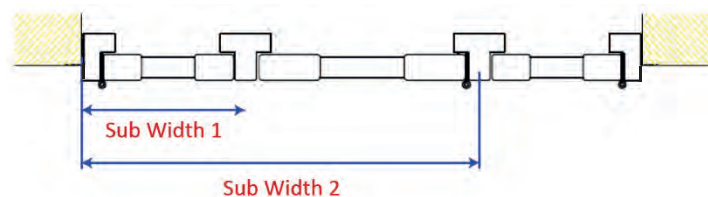

PANEL CONFIGURATION EXAMPLES – HINGED IN L FRAME

1 Panel, Configuration: L

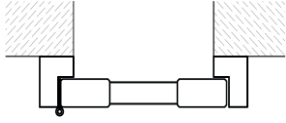

1 Panel, Configuration: R

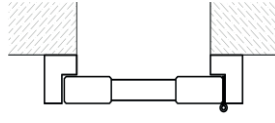

2 Panels, Configuration; L-DR

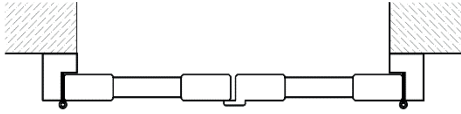

2 Panels with a T Post, Configuration; LTR

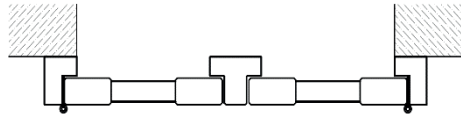

3 Panels, Configuration L-DRR

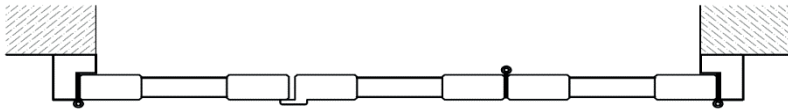

3 Panels with 2 T Posts, Configuration LTRTR

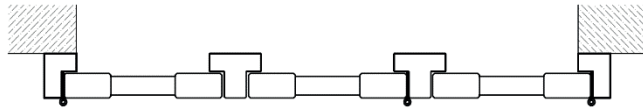

4 Panels, Configuration LL-DRR

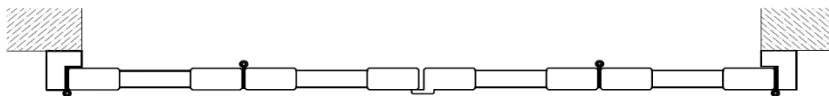

4 Panels with a T Post, Configuration L-DRTL-DR

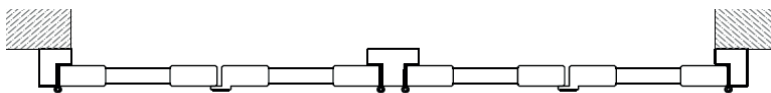

4 Panels with 3 T Posts, Configuration LTRTLTR

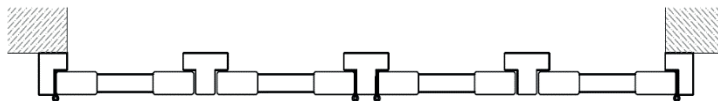

4 Panels with 3 Posts, Configuration LTL-DRTR

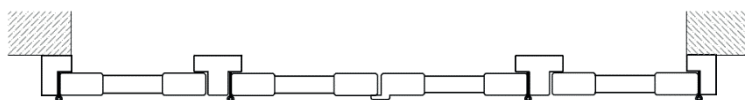

INSTALLATION METHOD: HINGED IN Z FRAME – Reveal Mount Only

Ideal for out of square windows or windows without architraves



Finish	Installation Method	Panel WIDTH		Panel HEIGHT		Panel Breaks			
		Min	Max	Min	Max	Mid-Rail(s) Required	Approximate split rotation by louvre size		
							64	89	114
Paulownia	Hinged in Z Frame	190	850	254	3000	1500, 2500	830	1035	1135
	Double Hinged	190	425	254	3000	1500, 2500	830	1035	1135
Basswood	Hinged in Z Frame	190	850	254	3000	1500, 2500	830	1035	1135
	Double Hinged	190	325	254	3000	1500, 2500	830	1035	1135
PVC	Hinged in Z Frame	190	850	254	3000	1500, 2500	830	1035	1135
	Double Hinged	190	425	254	3000	1500, 2500	830	1035	1135
Note: The factory will automatically split the tilt if order sizes exceed factory standards				Maximum number of louvres per tilt rod			15	13	11

** Please note double hinged overall width cannot exceed 850mm for Paulownia and PVC, 650mm for Basswood

Minimum Reveal Depths									
Hinged in Z Frame	64mm Louvre			89mm Louvre			114mm Louvre		
	Centre	Clearview	Concealed	Centre	Clearview	Concealed	Centre	Clearview	Concealed
	50.5	60.5	50.5	63	73	63	75.5	85.5	75.5

FRAME OPTIONS – HINGED IN Z FRAME

Z Frames are commonly used when there is no architrave, this frame will wrap around the reveal edge also making it ideal for covering out of square windows. The wide range of trims also allows you to achieve an architrave look.

A Z Frame is not recommended where an existing architrave is present, unless the opening is considerably out of square.

A Sill Plate Frame can be used along with Z Frames where it is unable to wrap around the opening, e.g. the bottom on a kitchen bench, the top on a bulkhead ceiling and so on. A sill plate is simply a L Frame in place of the Z Frame.

Frame Options

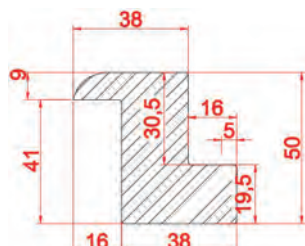

Standard Z40
Paulownia and Basswood

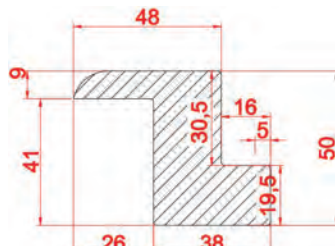

Standard Z50
Paulownia and Basswood

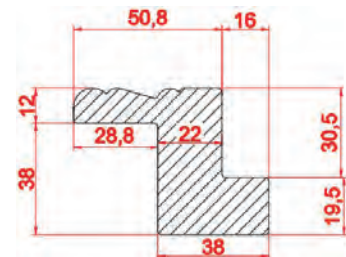

Deco Z2-BS
Paulownia and Basswood

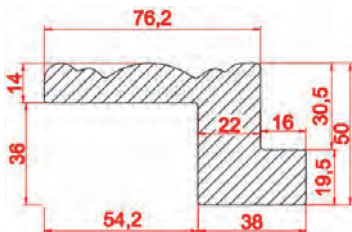

Deco Z3-CS
Paulownia and Basswood

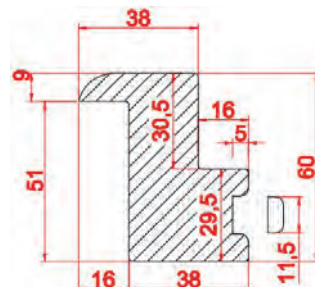

Deco Insert Z40SF
Paulownia and Basswood

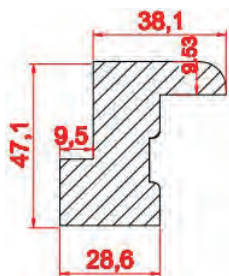

Standard Z40-BN
PVC

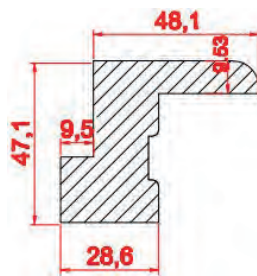

Standard Z50-BN
PVC

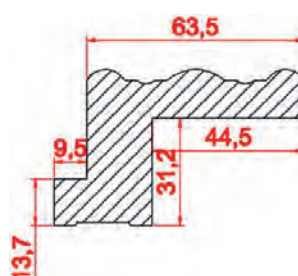

Deco Z2-BS
PVC

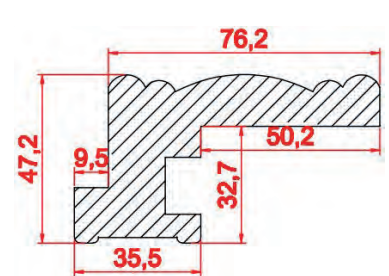

Deco Z3-CS
PVC

HOW TO MEASURE – HINGED IN Z FRAME

Reveal Mount Only

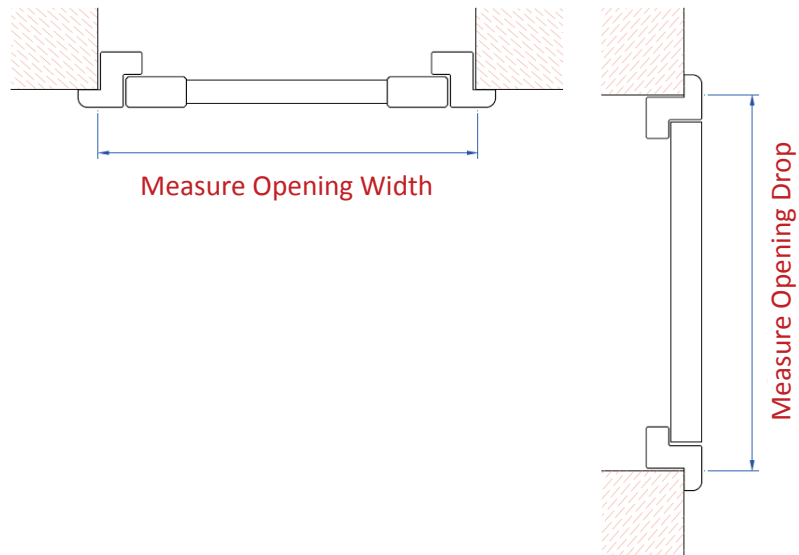

Important Notes:

The m2 price is calculated off the total finished shutter, the Z frame overlap will be added to the opening size when calculating the price.

If you would like T-Posts, you have 2 options:

1. EVEN PANEL SPACING: The overall width will be equally split to determine the placement of your T posts.
2. UNEVEN PANEL SPACING: If you required uneven panel sizes, please note the sub widths on your order form, where possible please submit the order with a drawing.

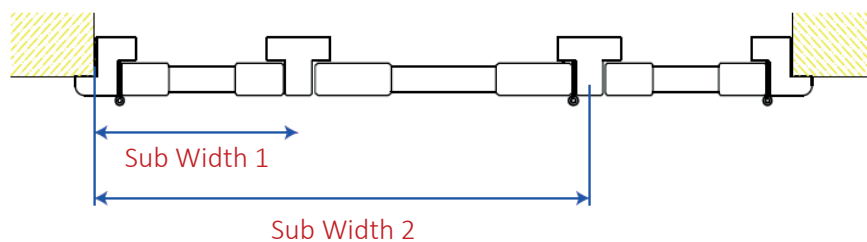

PANEL CONFIGURATION EXAMPLES – HINGED IN Z FRAME

1 Panel, Configuration: L

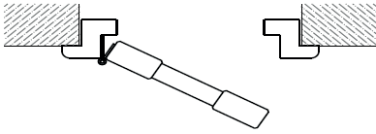

2 Panels, Configuration: L-DR

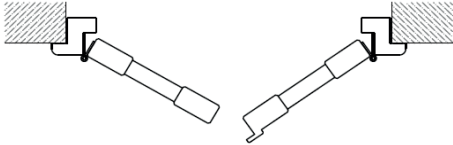

2 Panels with a T post, Configuration: LTR

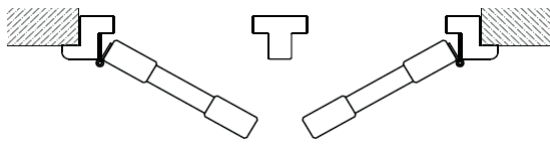

3 Panels, Configuration: L-DRR

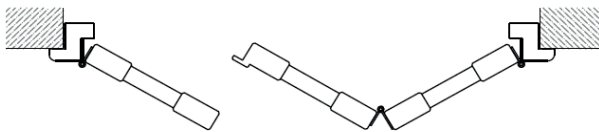

3 Panels with 2 T Posts, Configuration: LTRTR

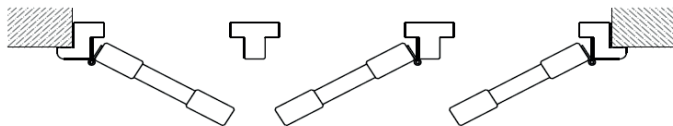

4 Panels, Configuration: LL-DRR

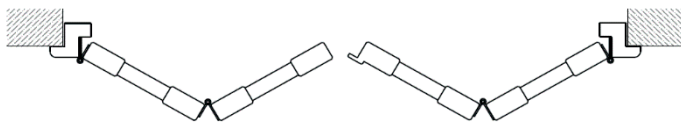

4 Panels with a T Post, Configuration: L-DRTLDR

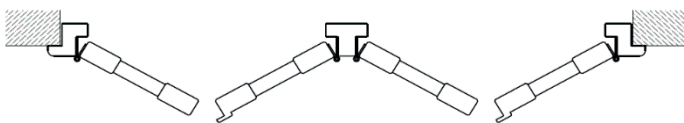

BAY AND CORNER POSTS – Available for both Hinged in L and Z Frames

For bay and corner windows when hinged in a L or Z frame to keep a consistent and clean look we suggest adding a bay or corner post (dependant on the angle)

To request a bay or corner post simply add it into your configuration.

Bay and corner shutter orders should be submitted with a drawing to ensure the factory have all the information to make the shutter off the correct post placement.

Custom bay posts are also available for different angles, please ensure to provide your angle requirement along with your drawings.

Paulownia and Basswood Posts

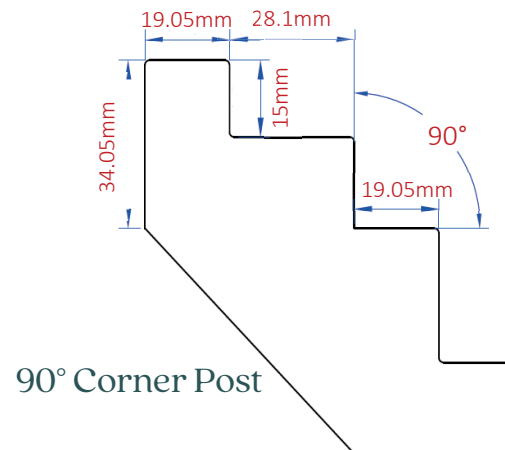
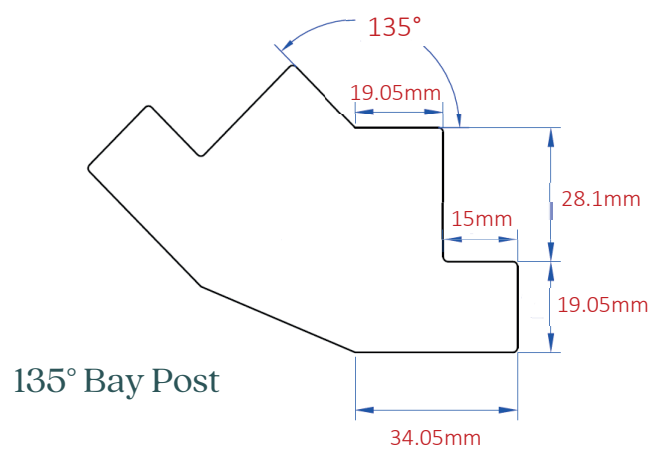

PVC Posts

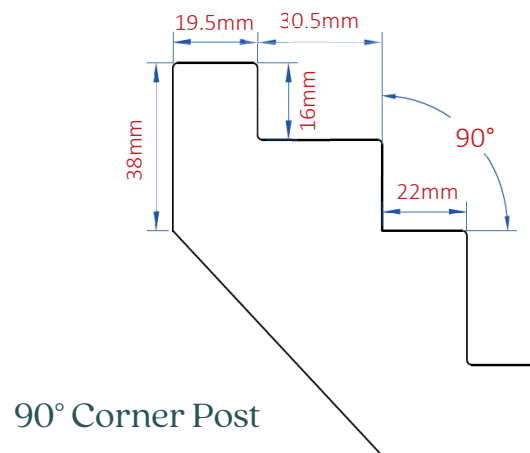
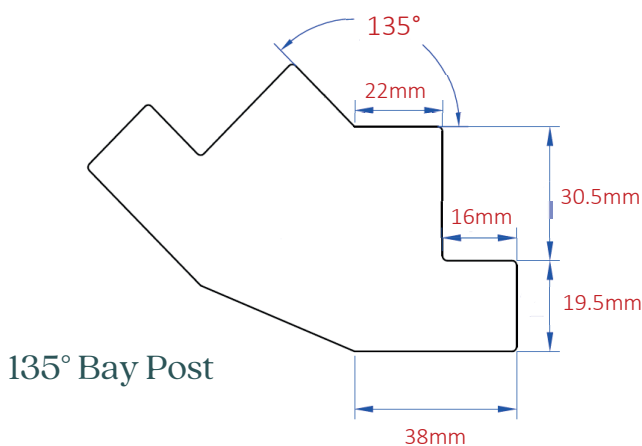

HOW TO MEASURE – CORNER AND BAY WINDOWS

Bay Window: Inside Mount
Available with both L and Z Frames

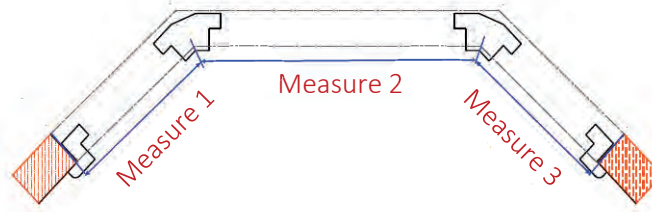

Bay Window: Outside Mount
Available with L Frames only

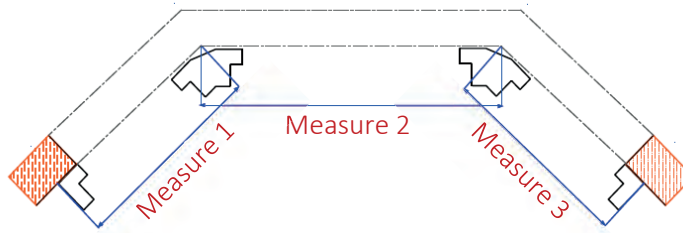

Corner Window: Inside Mount
Available with both L and Z Frames

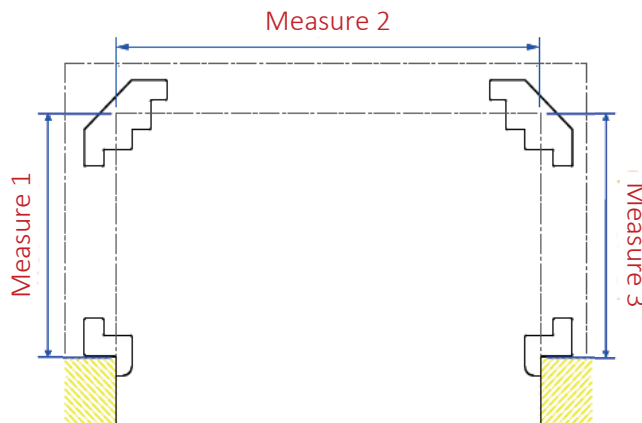

Corner Window: Outside Mount
Available with L Frames only

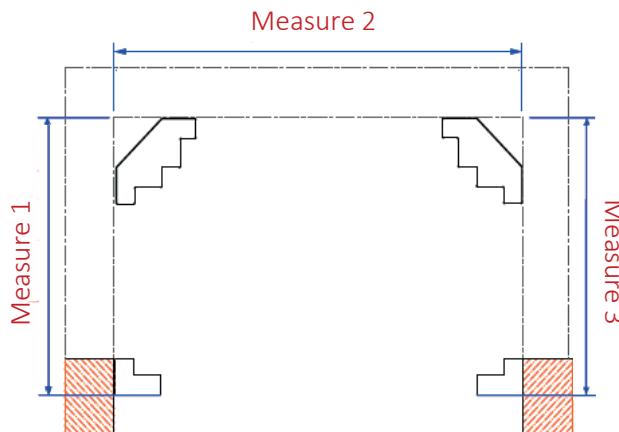

PANEL CONFIGURATION EXAMPLES – CORNER AND BAY WINDOWS

4 Panels and 2 bay posts, Configuration: LBL-DRBR

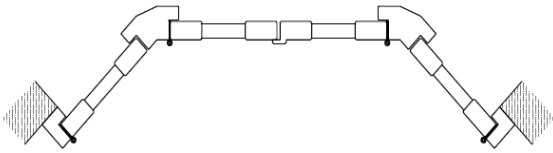

6 Panels and 2 bay posts, Configuration: LBLL-DRRBR

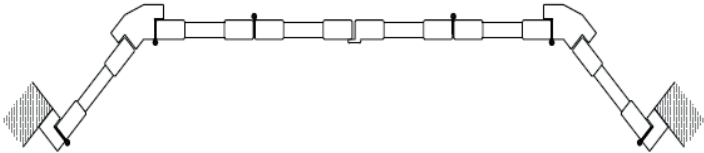

8 Panels and 2 bay posts, Configuration: L-DRBLL-DRRBL-DR

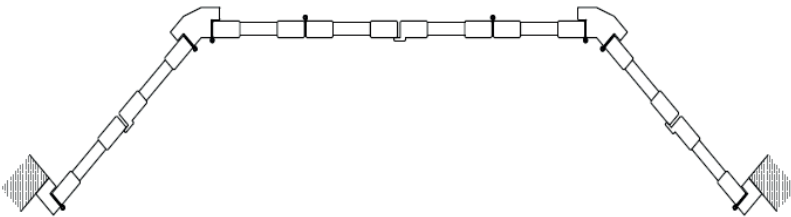

2 Panels and 1 corner post, Configuration: LCR

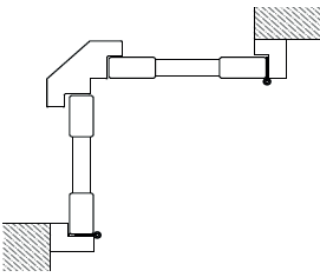

3 Panels and 1 corner post, Configuration: LCL-DR

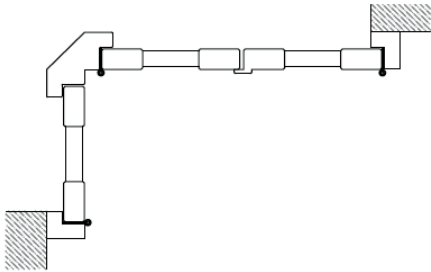

4 Panels, Configuration: L-DRCL-DR

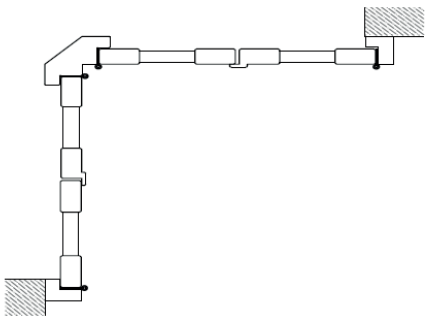

4 Panels, Configuration: LCL-DRCR

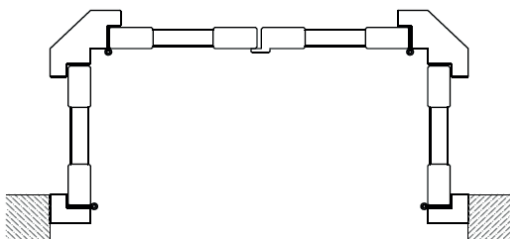

6 Panels, Configuration: LCLL-DRRCR

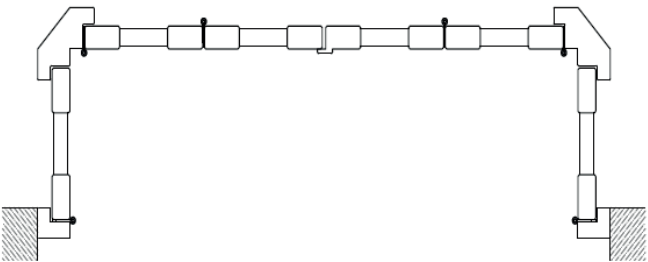

INSTALLATION METHOD: HINGED NO FRAME — Reveal and Face Mount



Finish	Installation Method	Panel WIDTH		Panel HEIGHT		Panel Breaks			
		Min	Max	Min	Max	Mid-Rail(s) Required	Approximate split rotation by louvre size		
							64	89	114
Paulownia	Hinged in L Frame	190	850	254	3000	1500, 2500	830	1035	1135
	Double Hinged	190	425	254	3000	1500, 2500	830	1035	1135
Basswood	Hinged in L Frame	190	850	254	3000	1500, 2500	830	1035	1135
	Double Hinged	190	325	254	3000	1500, 2500	830	1035	1135
PVC	Hinged in L Frame	190	850	254	3000	1500, 2500	830	1035	1135
	Double Hinged	190	425	254	3000	1500, 2500	830	1035	1135
Note: The factory will automatically split the tilt if order sizes exceed factory standards				Maximum number of louvres per tilt rod			15	13	11

** Please note double hinged overall width cannot exceed 850mm for Paulownia and PVC, 650mm for Basswood

Minimum Reveal Depths									
Hinged No Frame	64mm Louvre			89mm Louvre			114 Louvre		
	Centre	Clearview	Concealed	Centre	Clearview	Concealed	Centre	Clearview	Concealed
	50.5	60.5	50.5	63	73	63	75.5	85.5	75.5

HOW TO MEASURE – HINGED NO FRAME

Option 1: Non-Mortise Hinged – Reveal Mount Only

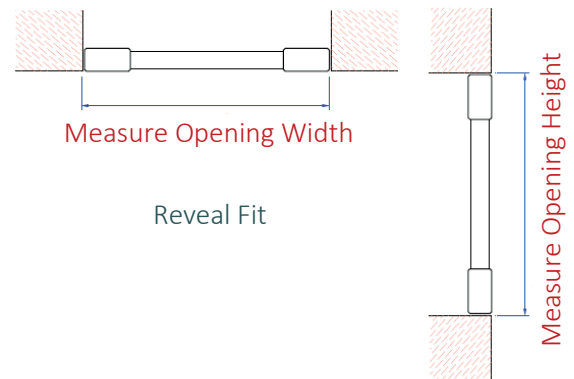

Option 2: Pivot Hinge – Reveal and Face Fit

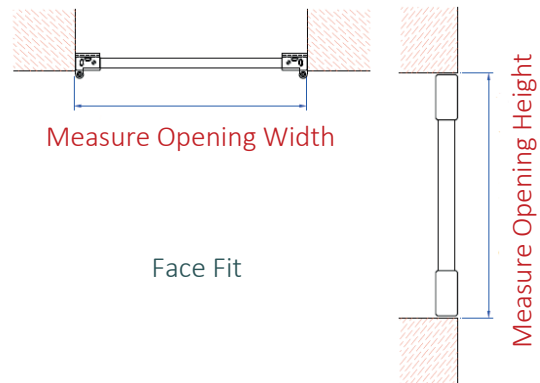
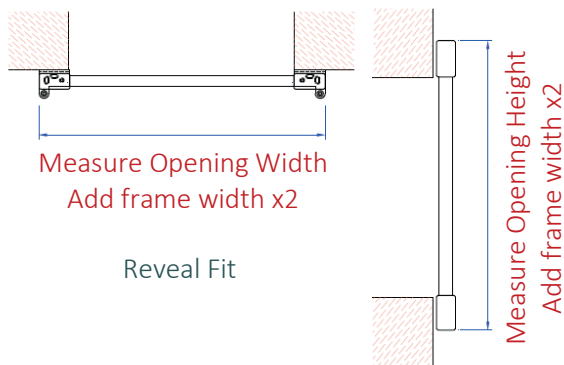

Option 2: L Hinge and Hang Strip – Reveal Mount Only

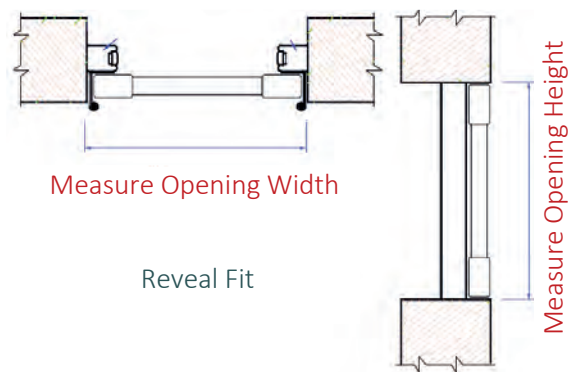
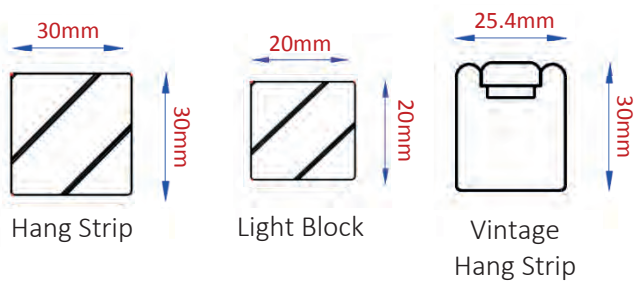

PANEL CONFIGURATION EXAMPLES: HINGED NO FRAME

1 Panel, Configuration: L

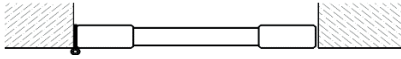

1 Panel, Configuration: R

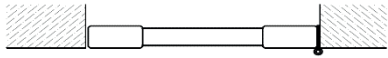

2 Panels, Configuration: L-DR



3 Panels, Configuration: LL-DR

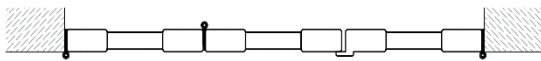

4 Panels, Configuration: LL-DRR



INSTALLATION METHOD: FIXED – Reveal Mount Only

Allowing panels to be in a fixed position while blades can still be rotated



Finish	Installation Method	Panel WIDTH		Panel HEIGHT		Panel Breaks			
		Min	Max	Min	Max	Mid-Rail(s) Required	Approximate split rotation by louvre size		
							64	89	114
Paulownia	Fixed	190	850	254	3000	1500, 2500	830	1035	1135
Basswood	Fixed	190	900	254	3000	1500, 2500	830	1035	1135
PVC	Fixed	190	900	254	3000	1500, 2500	830	1035	1135
Note: The factory will automatically split the tilt if order sizes exceed factory standards				Maximum number of louvres per tilt rod			15	13	11

Minimum Reveal Depths									
	64mm Louvre			89mm Louvre			114mm Louvre		
	Centre	Clearview	Concealed	Centre	Clearview	Concealed	Centre	Clearview	Concealed
Fixed	50.5	60.5	50.5	63	73	63	75.5	85.5	75.5

INSTALLATION OPTIONS - FIXED

Fixed with Bullet Magnets

Panel can be removed

- Option 1: Fixed with Bullet Magnets in L Frame
- Option 2: Fixed with Bullet Magnets in Z Frame
- Option 3: Fixed with Bullet Magnets with Light Block
- Option 4: Panel Only with Bullet Magnets

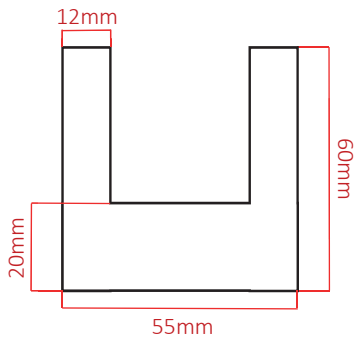
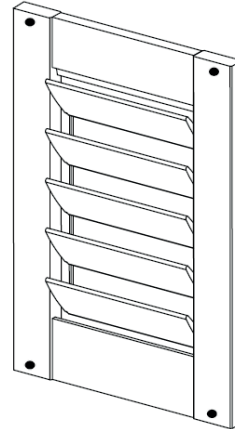

Top U Channel

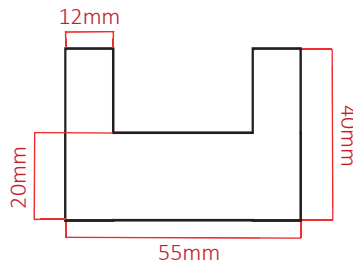

Bottom U Channel

Fixed in a U Channel

The best mounting method for fixed removal panels is by using a U channel at the top and bottom. The panel can be easily removed after installation by lifting the panel up and removing it out of the bottom channel first (much like a fly screen)

Fixed in a U Channel with Light Block

Panel can be removed with Light Block on the back only
Panel cannot be removed with Light Block both front and back.

Fixed panels with light block are suitable for reveal fit only. Lengths of light block can be installed on both the front and the back of the shutter holding the panels permanently in position. These panels are no longer removable.

This type of fixing is ideal for room dividers.

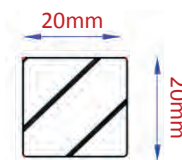

Light Block

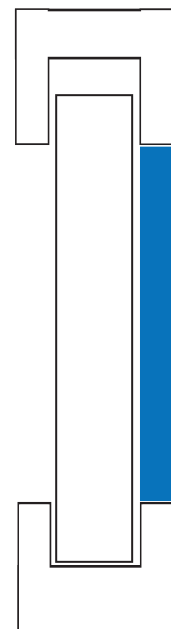

HOW TO MEASURE - FIXED

Fixed in U Channel

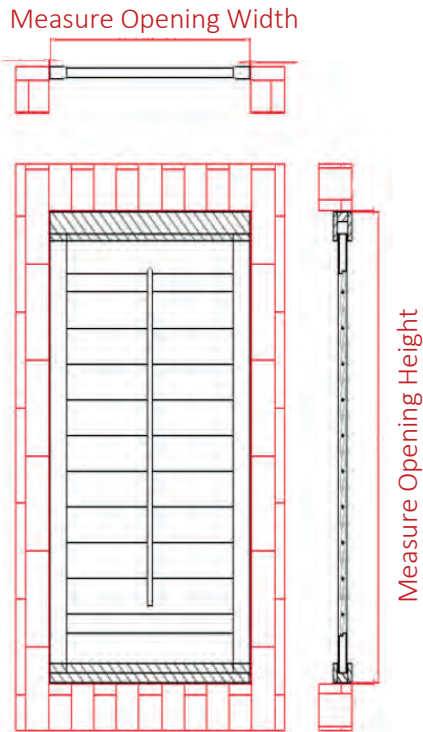

Fixed in In L or Z Frame

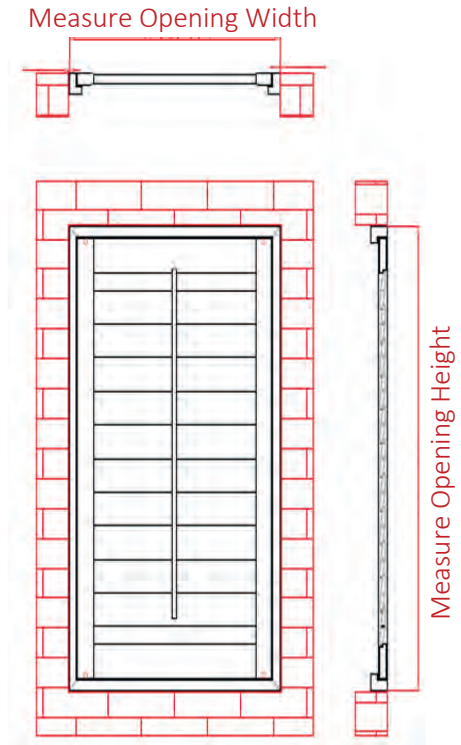

PANEL CONFIGURATION EXAMPLES - FIXED

1 Panel, Configuration: F

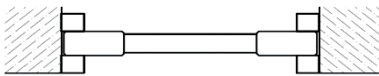

2 Panel, Configuration: FF



3 Panel, Configuration: FFF

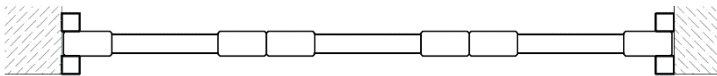

4 Panel, Configuration: FFFF



INSTALLATION METHOD: MULTI-FOLD — Face and Reveal Mount

Number of panels on each side must be EVEN, Max number of panels per side is 6



Finish	Installation Method	Panel WIDTH		Panel HEIGHT		Panel Breaks			
		Min	Max	Min	Max	Mid-Rail(s) Required	Approximate split rotation by louvre size		
							64	89	114
Paulownia	Multi-Fold	190	650	254	3000	1500, 2500	830	1035	1135
Basswood	Multi-Fold	190	650	254	3000	1500, 2500	830	1035	1135
PVC	Multi-Fold	190	650	254	3000	1500, 2500	830	1035	1135
Note: The factory will automatically split the tilt if order sizes exceed factory standards				Maximum number of louvres per tilt rod			15	13	11

Minimum Reveal Depths									
Multi-Fold	64mm Louvre			89mm Louvre			114mm Louvre		
	Centre	Clearview	Concealed	Centre	Clearview	Concealed	Centre	Clearview	Concealed
	50.5	60.5	50.5	63	73	63	75.5	85.5	75.5

MULTI-FOLD OPTIONS

Track Options

- A. If you need top, bottom, left and right sideboards, we will supply the standard top tracks and C Shape Bottom track for you.
- B. If you do not need the bottom board, we will supply you the standard top tracks and M shape bottom track for you directly
- C. If you only need us to supply the top and bottom track for you and dig the slot, we will supply you the standard top tracks and U shape bottom track directly.

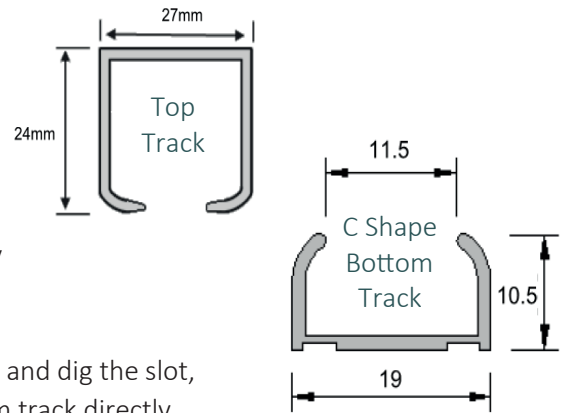

Fascia

65mm x 12mm Thickness

Side Boards

75mm x 20mm Thickness

Installation Type

Standard Fold: The panels open into the room (Open towards you)

Reverse Fold: The panels open to the outside (Away from you)

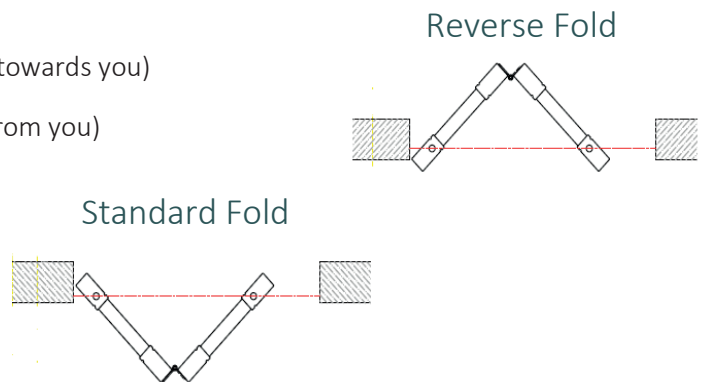

HOW TO MEASURE – MULTI-FOLD

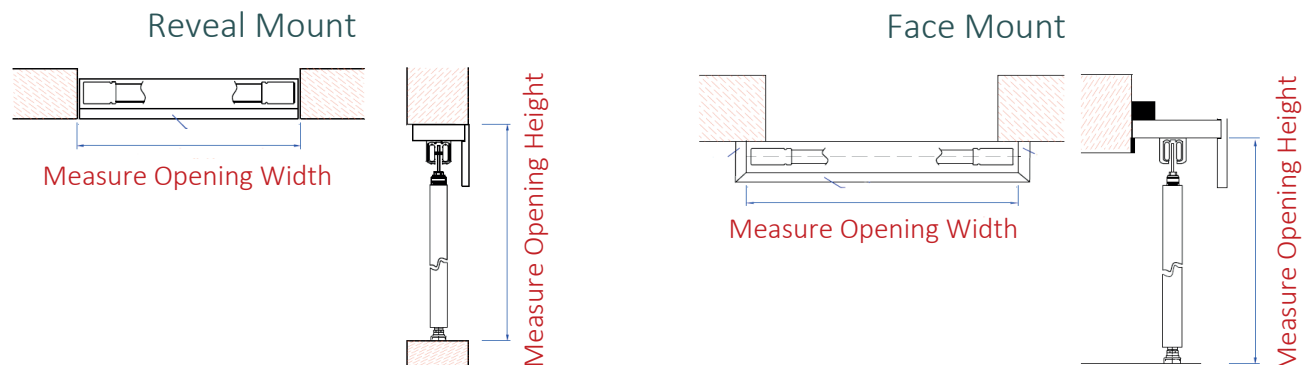

PANEL CONFIGURATION EXAMPLES: MULTI-FOLD

2 Panels, Configuration: LL

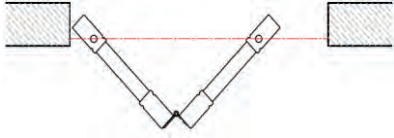

2 Panels, Configuration: RR

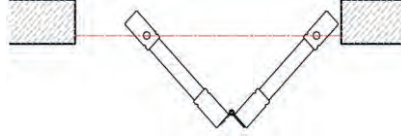

4 Panels, Configuration: LLLL

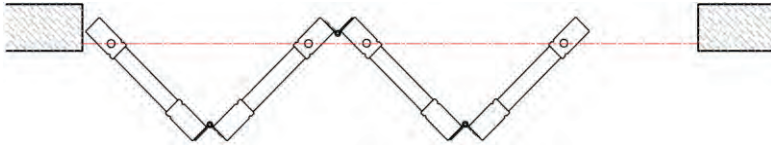

4 Panels, Configuration: RRRR

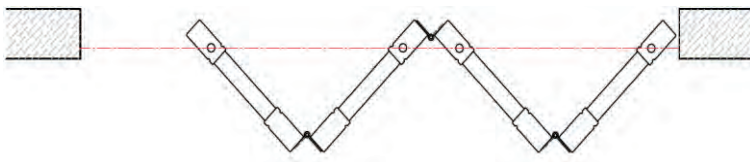

4 Panels, Configuration: LLRR

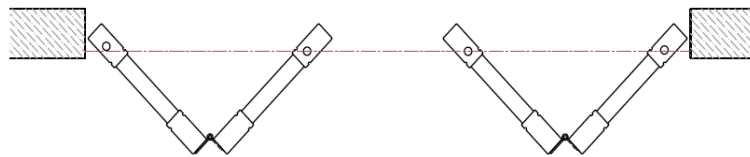

6 Panels, Configuration: LLLRRR

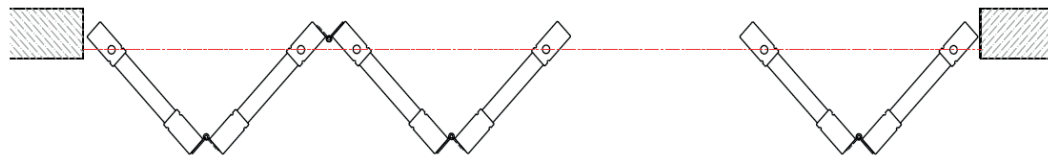

6 Panels, Configuration: LLRRRR

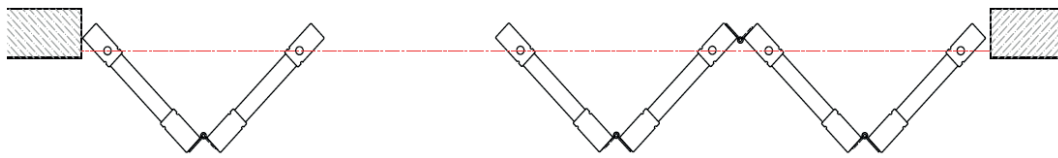

Important Notes:

When ordering multi-fold shutters using a centre tilt rod with more than two panels folded to one side, the tilt rod will automatically be staggered by 7mm to avoid any collision.

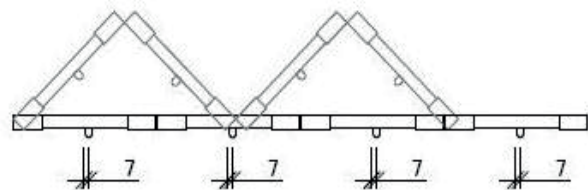

INSTALLATION METHOD: SLIDING — Face and Reveal Mount



Finish	Installation Method	Panel WIDTH		Panel HEIGHT		Panel Breaks			
		Min	Max	Min	Max	Mid-Rail(s) Required	Approximate split rotation by louvre size		
							64	89	114
Paulownia	Sliding	190	850	254	3000	1500, 2500	830	1035	1135
Basswood	Sliding	190	850	254	3000	1500, 2500	830	1035	1135
PVC	Sliding	190	850	254	3000	1500, 2500	830	1035	1135
Note: The factory will automatically split the tilt if order sizes exceed factory standards				Maximum number of louvres per tilt rod			15	13	11

Please note: When the Width is more than 800mm panels will come with a centre stile.

Minimum Reveal Depths						
Sliding	64mm Louvre		89mm Louvre		114mm Louvre	
	Centre or Offset	Clearview or Concealed	Centre or Offset	Clearview or Concealed	Centre or Offset	Clearview or Concealed
2 Tracks Closed	132	122	132	122	132	122
2 Tracks Open	176	162	202	182	222	212

HOW TO MEASURE - SLIDING

Reveal Mount

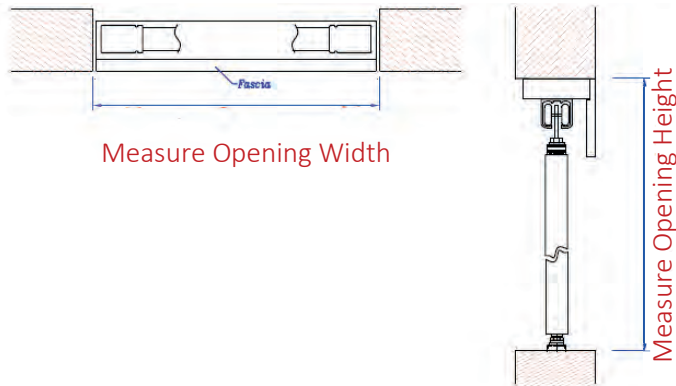

Face Mount

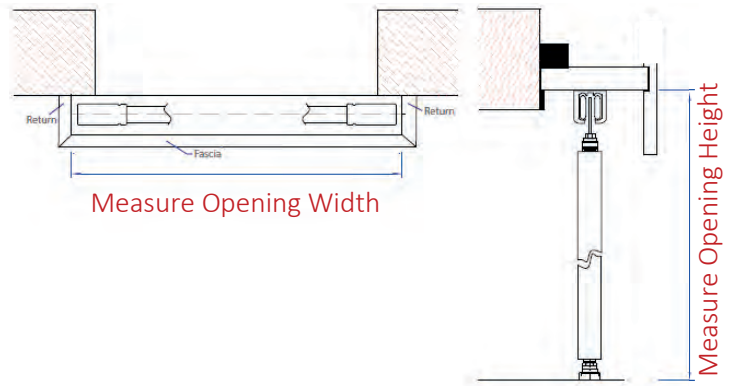

PANEL CONFIGURATION EXAMPLES - SLIDING

2 Track System, 2 Panels Configuration: BF

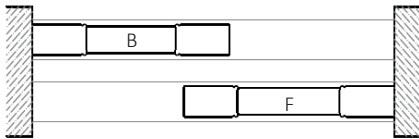

2 Track System, 3 Panels Configuration: BFB

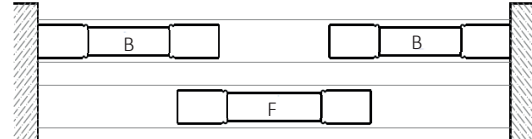

2 Track System, 3 Panels Configuration: FBB

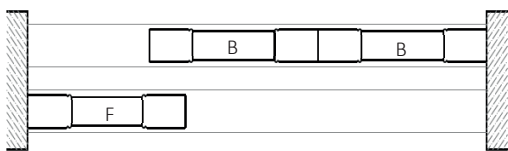

3 Track System, 3 Panels Configuration: FMB

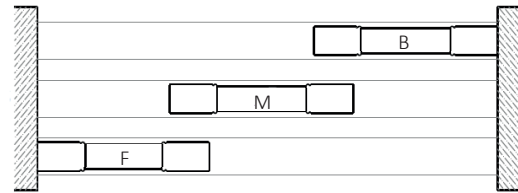

2 Track System, 4 Panels Configuration: BFFB

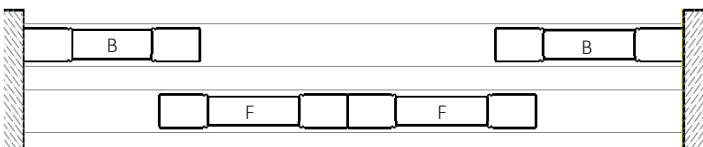

SLIDING OPTIONS

Track Options

- A. Track C with Bottom Board
- B. M Track
- C. T Shape Bottom Guide

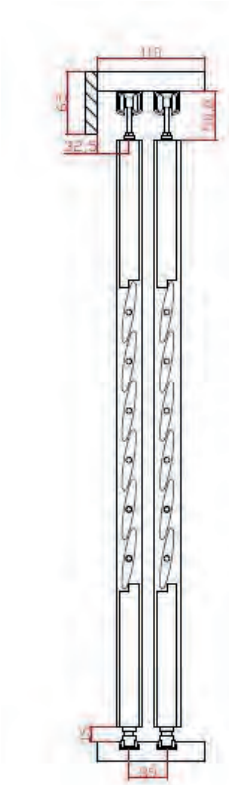

Track C with Bottom Board

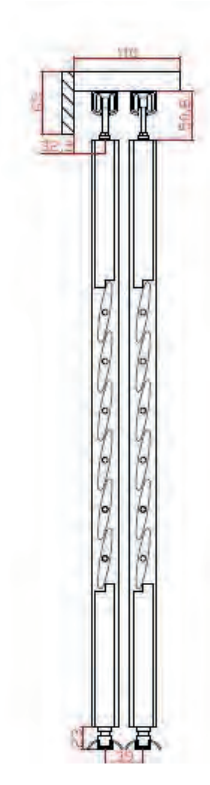

M Track

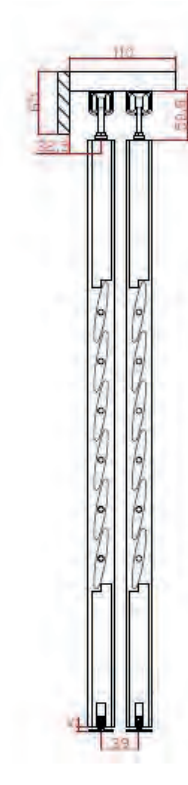

T Shape Bottom Guide

Fascia

100mm x 12mm Thickness

150mm x 12mm Thickness

Side Boards

100 x 20mm Thickness

140 x 20mm Thickness

160 x 20mm Thickness

200 x 20mm Thickness

220 x 20mm Thickness

SLIDING OPTIONS

Louvre: 64mm
Louvres Closed

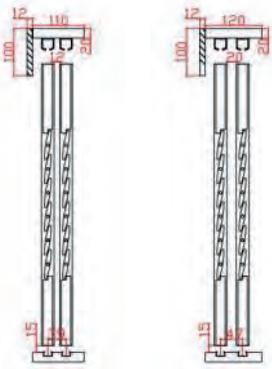

Clearview or
Concealed

Centre or
Offset

Louvre: 64mm
Louvres Open

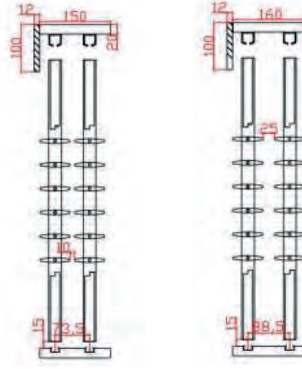

Clearview or
Concealed

Centre or
Offset

Louvre: 89mm
Louvres Closed

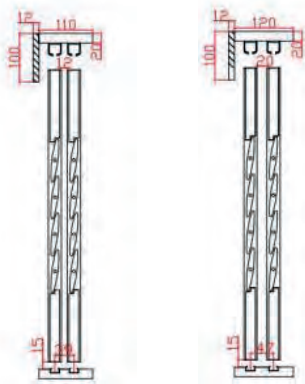

Clearview or
Concealed

Centre or
Offset

Louvre: 89mm
Louvres Open

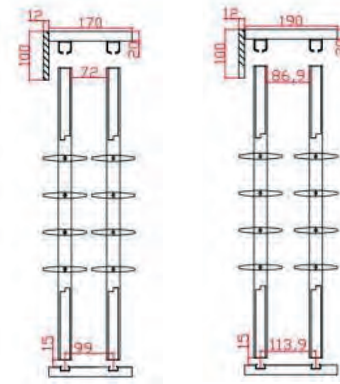

Clearview or
Concealed

Centre or
Offset

Louvre: 114mm
Louvres Closed

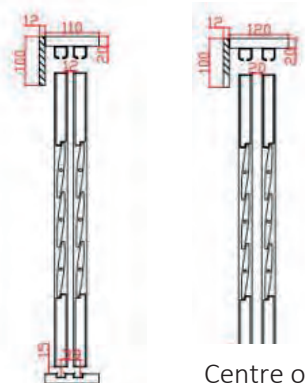

Concealed

Centre or
Offset

Louvre: 114mm
Louvres Open

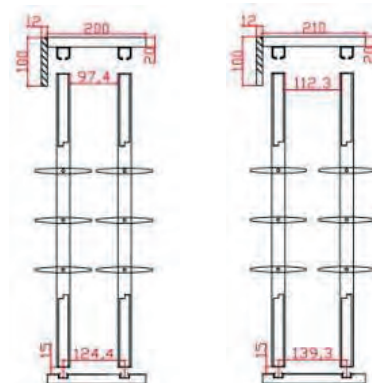

Concealed

Offset

SOLID PANELS

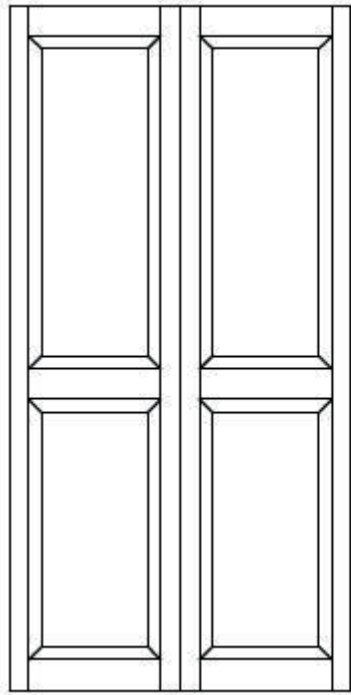

Solid Panels Only

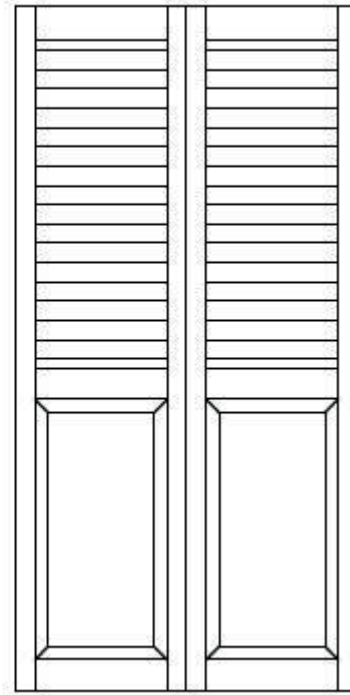

Combination

Solid Panel Options Available:

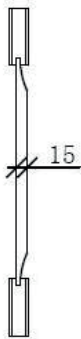

Option 1: Single raise



Option 2: Double raise

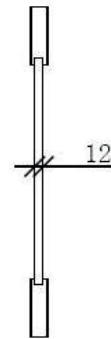

Option 3: Flat

FRENCH DOOR CUT-OUTS

Square and Round cut outs available.

Orders with French door cut outs must be accompanied by the correct French Door Cut out order form.

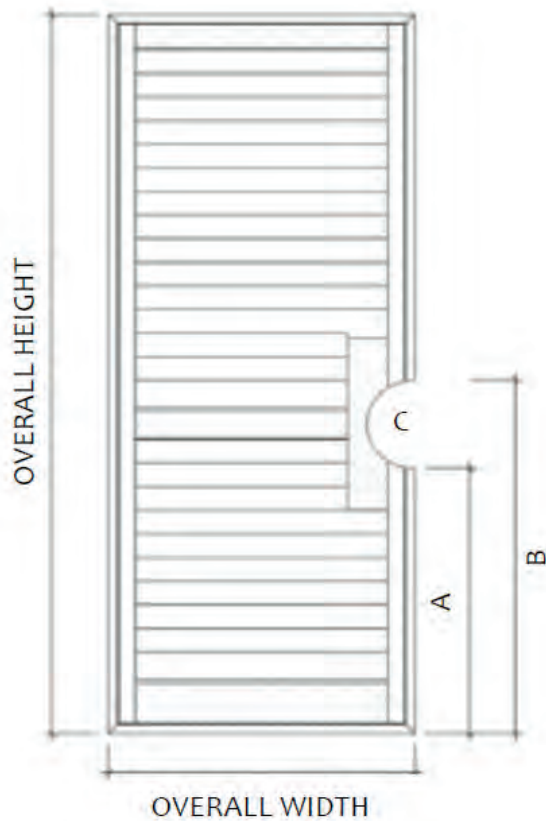
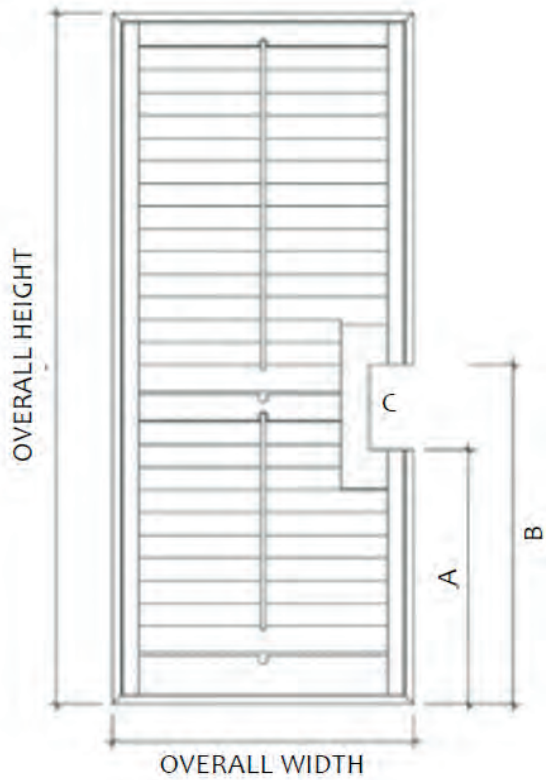

Cut-out Options Available

Type A: Curved Flush Cut-out

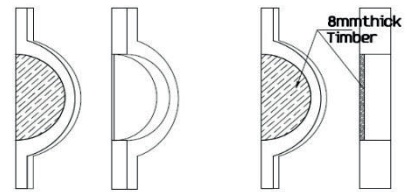

Type B: Curved Offset Cut-out

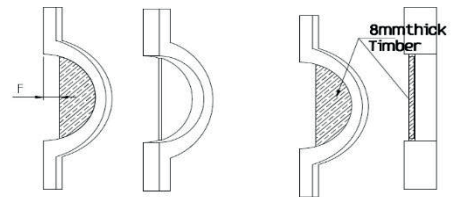

Type C: Rectangular Flush Cut-out

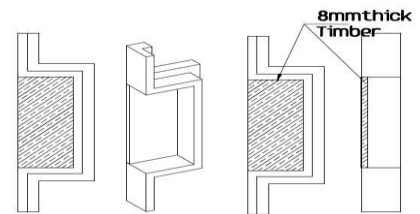

Type D: Rectangular Offset Cut-out

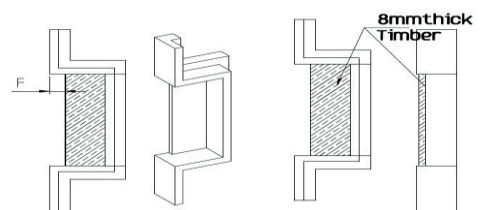

SPECIAL SHAPES

Special Shaped Shutters area available in L and Z Frames or fixed with bullet magnets.

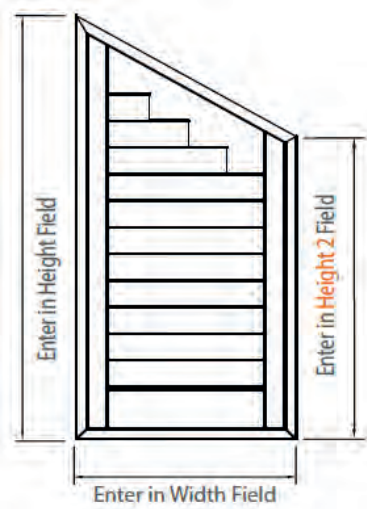

Right Rake

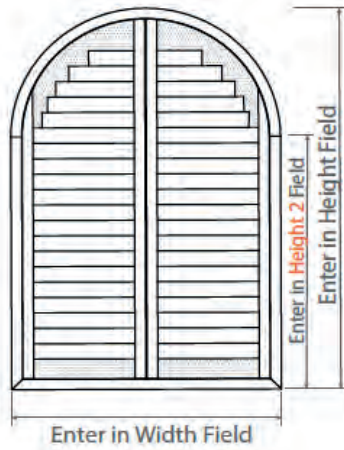

Arch

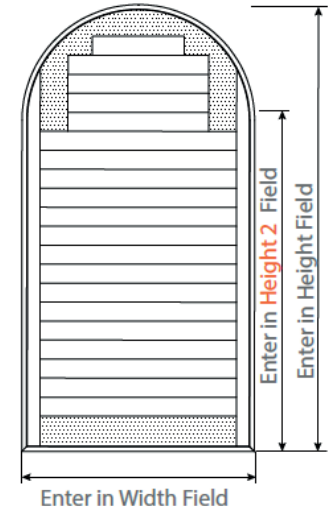

Arch

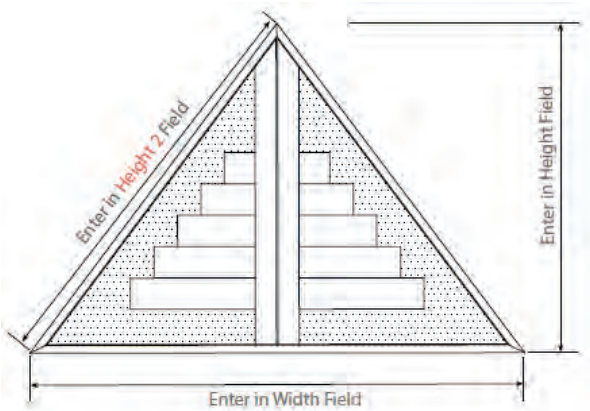

Triangle

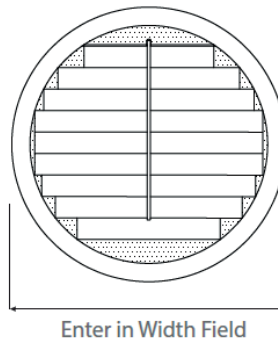

Circle

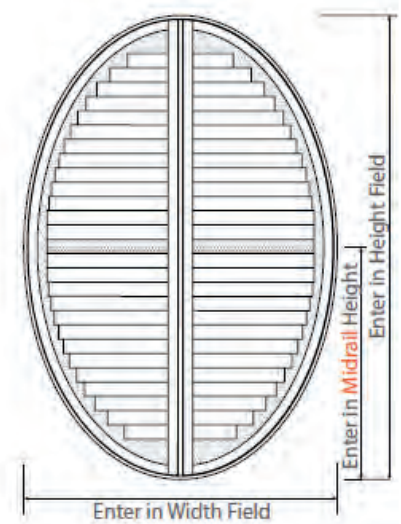

Oval

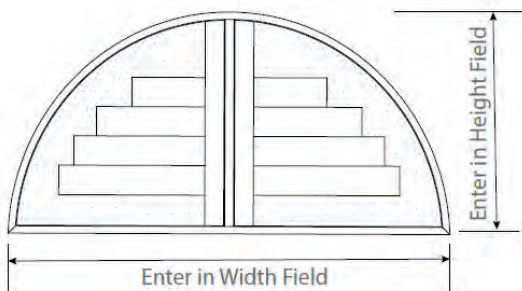

Half Arch

Important Notes:

All special shaped shutters must be accompanied by a drawing/ template with all measurements required.

The factory will also send through a final drawing for approval before submitting into production



Sanctuary

S H U T T E R S

www.sanctuaryshutters.co.uk



Unit 400, Catesby Business Park, Kings Norton, Birmingham, West Midlands, B38 8SE

Tel: 0121 433 3302 | Fax: 0121 459 5438

Email: sales@harrisparts.co.uk | Web: www.harrisparts.co.uk



@harrisparts1



/harrispartslimited